

CATÁLOGO

W o r k p l a c e S o l u t i o n s

JGORBE®

J'GORBE®



La empresa The company / L'entreprise

J.GORBE es una sociedad, dedicada a la fabricación de mobiliario de oficina de series operacionales y de semidirección, elaborados con componentes de primera calidad.

Con unas instalaciones en planta de 15.000 m², ubicados en Teruel fue creada en 1978, habiendo mantenido un desarrollo sostenido desde su inicio, que la ha situado entre los líderes del mercado.

Con la preocupación máxima en cuanto a la calidad, el diseño y la funcionalidad del producto, cuenta con un centro de proyectos I+D altamente cualificado, en el que desarrollan los productos que se muestran en el catálogo, así como se elaboran las propuestas de proyectos integrales personalizados, adecuados a las necesidades de nuestros clientes.

JGORBE is a company dedicated to the furniture office for operating ranges and for intermediate posts devices produced since 1978 with high quality components.

Located in Teruel, where its installations use 15.000 m².

It has not stopped to develop since its beginnings and that has placed it among the market lidars.

With the quality, the design and the fonctionality of the product like principal worry JGORBE disposes of a I+D projects center highly qualified where are developed catalogue products and where are also elaborated integral personalised projects adapted to its customers' requirements.

JGORBE est une entreprise qui se consacre depuis 1978 à la fabrication de mobilier de bureau de séries opérationnelles et pour postes intermédiaires élaborés avec des composants de première qualité.

Située à Téruel, dans des installations qui occupent 15.000 m², elle n'a cessé de se développer depuis ses débuts ce qui l'a située entre les lidars du marché.

Avec comme principale préoccupation la qualité, le design et la fonctionnalité du produit, JGORBE dispose d'un centre de projects I+D hautement qualifié où se développent les produits du catalogue d'une part, et où s'élaborent également des propositions de projects intégraux personnalisés et adaptés aux besoins de ses clients.



Diseñadores

Design / Design

www.jgorbe.es/designers.html

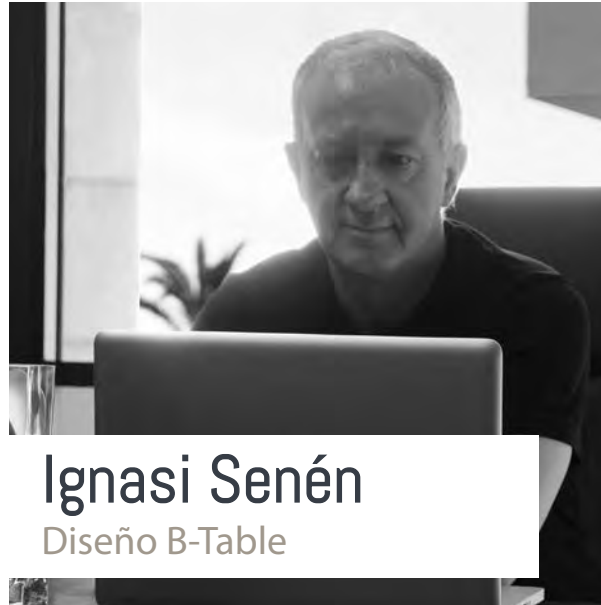

Ignasi Senén
Diseño B-Table

Soy diseñador industrial con casi cuarenta años de experiencia. Comencé de muy joven en el departamento creativo de la empresa más importante del mercado español en aquella época, Muebles Palau, en el que pasé 12 años. En 1988 decidí crear mi propio estudio con un equipo de colaboradores y empecé a trabajar para varios mercados. Mis diseños están presentes en tiendas de casi toda Europa, así como Estados Unidos, Brasil, Países Árabes, etc. He expuesto en las principales ferias internacionales: Milán, Colonia, París, Bolonia, Frankfurt, Oporto, Valencia y Bento Gonçalves, entre otras.

Mi filosofía de trabajo está regida por mis principios, basados en mi experiencia en fabricación, unida siempre a la idiosincrasia de la empresa para la que trabajo y a las posibilidades de sus sistemas de fabricación, aportando las variables precisas para adaptarme al mercado al cual va dirigido el mueble. Soy muy selectivo a la hora de elegir clientes, ya que para mí es básica la integración en la empresa para poder sacar el mayor fruto a sus proyectos. Para mí, el diseñador ha de ser una pieza más del engranaje de la empresa, un integrante de su equipo, que hable el mismo idioma y conozca en cada momento hacia dónde hay que ir con cada nuevo proyecto. Es una labor de tiempo que requiere situarse en el epicentro y evaluar todas las opciones, eligiendo lo mejor para cada cliente. Sin extravagancias y sin ir más allá las necesidades reales, pero creando un producto que marque diferencias.

Tengo un estilo marcadamente moderno, pero por mis conocimientos de fabricación y mi experiencia en varios mercados, puedo adaptarme a cualquier necesidad, aprovechando el potencial de la empresa.



Maurizio Bernabei
Diseño M3

Maurizio Bernabei, arquitecto, diseñador, en constante búsqueda de la ligereza, la sencillez, la claridad y la honestidad entre idea y proyecto.

Desde el sueño del diseño, a la experiencia de la ética en el diseño: una pasión por el trabajo que está en constante evolución a través del contacto directo con los artesanos, los empresarios y los que saben cómo traducir una buena idea en un buen proyecto.

Tras la Licenciatura en Arquitectura, cursa el Master en Diseño Industrial en la Escuela Politécnica de Milán y empieza a conocer de primera mano las empresas con las que establece buenas sinergias de trabajo: aprende que el gran valor del diseño, es que detrás de las empresas grandes y pequeñas hay siempre unas relaciones humanas que marcan la diferencia en el mercado, cuando la filosofía y el espíritu del equipo se traducen en servicios y productos de calidad.

El reto más grande de su creatividad es llegar a reinterpretar las formas y los conceptos, según la lógica de uso siempre en continua evolución.

Su sensibilidad aunando arquitectura y diseño, le hace aportar una visión global del proyecto, 'de la cucharita a la ciudad', como era el lema de la Bauhaus.

Participa en diferentes ediciones de la Feria del Mueble de Milán, presentando colecciones de sofás, muebles y lámparas, entre los jóvenes diseñadores de toda Europa en el FuoriSalone, obteniendo una buena acogida por parte de público y prensa.



Lorena Herrero

Diseño G3

Lorena Herrero es diseñadora de interiores y de producto, una gran apasionada del diseño y por ello su formación académica y laboral ha girado en torno al diseño y la arquitectura. Ha realizado importantes trabajos de interiorismo, de escaparatismo y de diseño de mobiliario.

Los espacios y los productos diseñados por Lorena tienen un carácter fresco y actual, tratando de buscar siempre el equilibrio entre la forma, la función y la estética con formas sencillas pero atractivas para los usuarios.

Su filosofía de trabajo y de percepción del diseño se demuestra en la Línea G3, ya que el diseño es poner soluciones funcionales a las necesidades de los usuarios y adaptarlo a la estética actual.



Mamen Porto

Diseño corporativo - web

Llevo trabajando en el mundo del diseño gráfico desde hace más de 30 años, desarrollando mi actividad profesional para empresas de Teruel, Zaragoza, Madrid, Toledo, Ibiza o Málaga.

Actualmente y desde hace 10 años trabajo como autónoma freelance dentro del mundo del diseño y las nuevas tecnologías enfocadas a internet.

Me entusiasma mi trabajo e intento plasmarlo en cada uno de los proyectos que pongo en marcha, con la misma ilusión que cuando empecé hace ya tanto tiempo.

Trabajar en proyectos integrales es todo un reto, como hago para clientes como JGorbe, para quien diseño catálogos de productos, página web, App, etc... También colaboro en el desarrollo de diseño para interiores de oficinas o aplicaciones informáticas de su empresa.

El diseño es mi pasión.



JGorbe

Equipo I+D JGorbe

Calidad y versatilidad, nuestra filosofía a la hora de diseñar.

En el diseño de nuestras líneas pensamos siempre en el día a día de cada uno de los puestos de trabajo de su empresa, desde dirección hasta recepción pasando por los puestos administrativos, siempre hemos procurado desarrollar un confort y una habitabilidad pensando en las personas que ejercen ese trabajo.

Simulador de color

Colour Simulator
Simulateur de couleur

Nuestra página web dispone de un simulador de color para todos los acabados en melamina y PVC así como para los acabados de las estructuras metálicas de todas nuestras series y modelos.

Es una manera sencilla de ver las distintas combinaciones de las que disponemos ya que nuestro cliente puede ver al momento cuál de ellas se adapta mejor a sus necesidades.

Our web page has a colour simulator with all our melamine and PVC finishes and with those of our metallic structures for all our product ranges.

It is the easier way for our customers to see immediatly which of our different combinations we have available adapts better to their needs.

Notre page web dispose d'un simulateur de couleur pour toutes les finitions en mélamine et en PVC ainsi que pour celles des structures métalliques des produits de toutes nos séries.

C'est la façon la plus simple de voir les différentes combinaisons dont nous disposons puisque notre client peut voir de forma immédiate laquelle s'adapte le mieux à ses besoins.

www.jgorbe.es/simulador-de-color.html



Mesas



Bench



Mesas de reunión



Recepción



Archivo PVC



Archivo G3



Archivo bmelamina



Polivalentes



Call center



Mesas de reunión

LÍDER

BENELUX

OMEGA

G3

NEKO EXECUTIVE

ANETO-CARVING

COLOR



MUESTRAS

BLANCO (BL)
WHITE / BLANC



BL
AL
NG

OLMO (OM)
ELM / ORME



BL
AL
NG

NEBRASKA (NB)
NEBRASKA / NEBRASKA



BL
AL
NG

GRIS CLARO (GC)
LIGHT GREY / GRIS CLAIR



BL
AL
NG

ACACIA (AC)
ACACIA / ACACIA



BL
AL
NG

STOCK EXPRESS

www.jgorbe.es/stock-express.html



Mesas, armarios,
cajoneras, sillas

bureaux, armoires, caissons, sièges
desks, bookcases, pedestal, chairs

¡¡Todo con la mejor calidad y entrega inmediata!!

Une qualité excellente et une livraison très rapide

All with the best quality and immediate delivery

Proveedores

Suppliers / Fournisseurs

www.jgorbe.es/empresa.html

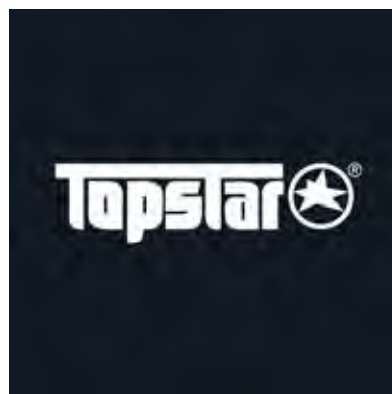

Proyectos realizados

Projects carried out
Projets réalisés

www.jgorbe.es/proyectos-realizados.html

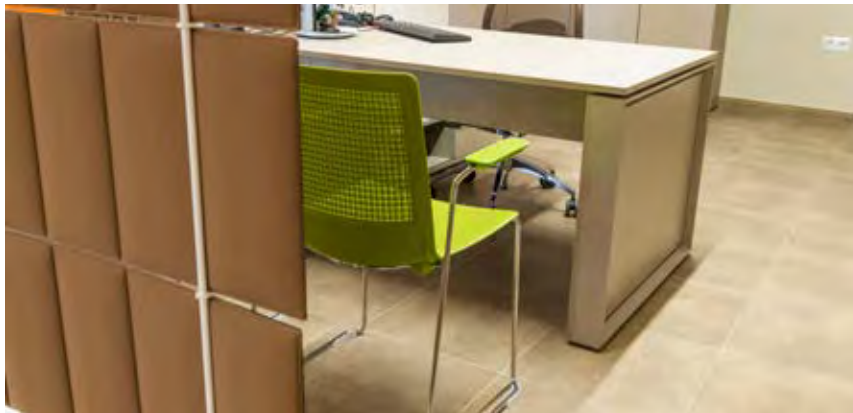





B-Table





B-Table

B-Table es una línea ejecutiva ganadora del prestigioso premio RED DOT DESIGN AWARD. Fabricada mediante inyección de aluminio tiene dos acabados: el propio aluminio pulido efecto cromo o aluminio pintado mediante pintura en polvo de alta resistencia en color negro. También está disponible una versión en madera maciza de roble barnizado. Melamina, M.D.F laminado sintético mate o barnizado, cristal transparente o mate blanco son las diferentes opciones para la encimera de la mesa. Y por supuesto en diferentes medidas que harán de la **B-Table** la aliada perfecta para su despacho de dirección.

B-Table is a range thought for Executives which has won the prestigious RED DOT DESIGN AWARD prize. Produced in injected aluminium with two finishes: polished aluminium with chrome finish or black aluminium pigmented with a high resistance powdered paint. A version in varnish solid oak is also available. The desktop could be in melamine, synthetic MDF with a matt or varnished finish or transparent or matt white glass. Available in different measurements, the versatility of the **B-Table** made it a perfect ally of your company's executive office.

B-Table est une ligne pensée pour Exécutifs qui a obtenu le prestigieux prix RED DOT DESIGN AWARD. Fabriquée en aluminium injecté en deux finitions: aluminium poli effet chromé ou aluminium noir teinté avec une peinture en poudre hautement résistante. Une version en bois de chêne massif et verni est également disponible. Quant au plateau, il peut être en mélamine, en MDF ynthétique avec une finition mate ou vernie ou en verre avec une finition transparente ou en blanc mat. Disponible en différentes mesures la versatilité de la **B-Table** en fait une parfaite alliée du bureau de direction de votre entreprise.

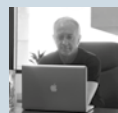

Desarrollado por **IGNASI SENÉN**
Developed by **IGNASI SENÉN** / Développé par **IGNASI SENÉN**

ACABADOS ESTRUCTURAS / STRUCTURE FINISHES / FINITIONS DE LA STRUCTURE



Madera Roble
Solid oak / Chêne massif



Aluminio pulido
Polished aluminium / Aluminium poli



Negro epoxi
epoxy black / epoxy noir

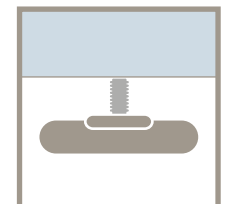
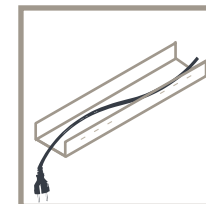
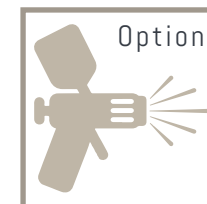
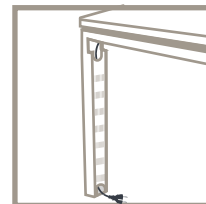

ACABADOS EN PVC MATE/BARNIZADO

PVC FINISHES MATT/VERNISH / FINITIONS EN PVC MAT/VERNI



NO

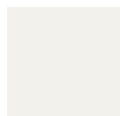

BZ

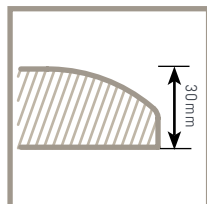

OL



CA

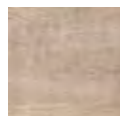

BA



ACABADOS MELAMINA

MELAMINE FINISHES / FINITIONS EN MÉLAMINE

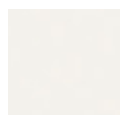

BL



OM

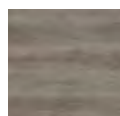

NB



GC



AC



ACABADOS CRISTAL

GLASS FINISHES / FINITIONS EN VERRE



CR-MB



CR-TR



Méridas en cm / Measurements in centimeters / Mesures en centimètres

CRISTAL / GLASS / VERRE

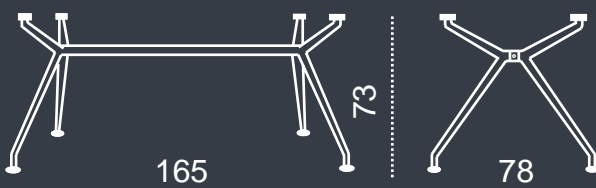

MADERA / WOOD / BOIS
CRISTAL / GLASS / VERRE

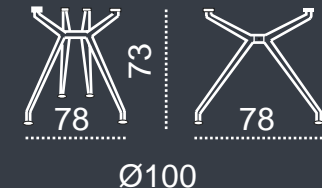

Ø100

MADERA / WOOD / BOIS

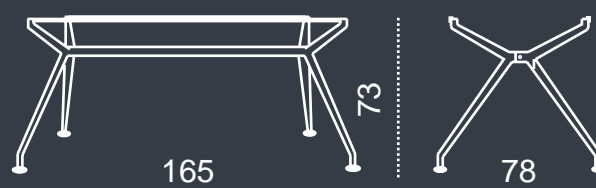

180*90/200*90
220*110

TABLERO
DESKTOPS / PLATEAUX



Líder

Lider / Lider





Líder

Lider / Lider

La colección **Líder** nos deleita con soluciones exclusivas de una auténtica línea de alta dirección, cuidadas formas y atractivos detalles que la hacen única. Además, con sus colores y sus dos acabados: mate y barnizado, ofrece un nivel de personalización exclusivo.

The **Lider** collection delights us with its exclusive solutions worthy of a top management. Its cared forms and its attractive details made it nique. In addition, with its colors and its two finishes: mat and varnished, the collection offers an exclusive level of personalization.

La collection **Lider** nous ravit avec ses solutions exclusives dignes d'une authentique ligne pour haute direction. Ses formes soignées et ses détails attractifs la font unique. En plus, avec ses couleurs et ses deux finitions: en mat et en verni, la collection nous offre un niveau de personnalisation exclusif.

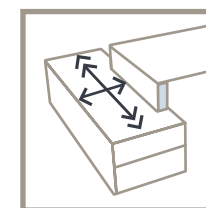
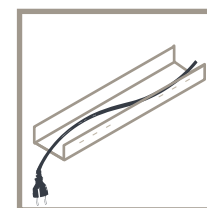
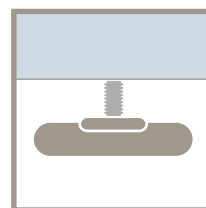
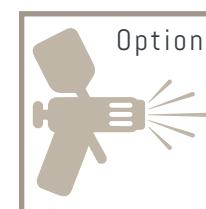
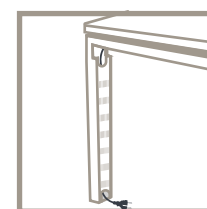
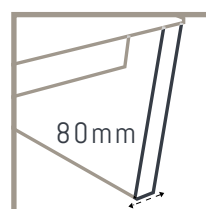

Desarrollado por el equipo de I+D **JGORBE**
 Developed by the JGORBE I + D team / Développé par l'équipe I + D de JGORBE

ACABADOS EN PVC MATE/BARNIZADO
PVC FINISHES MATT/VERNISH / FINITIONS EN PVC MAT/VERNI



NO

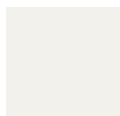

BZ

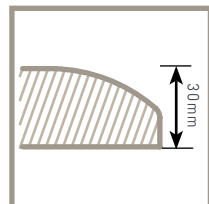

OL



CA



BA



PAS240



PAS100

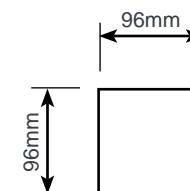
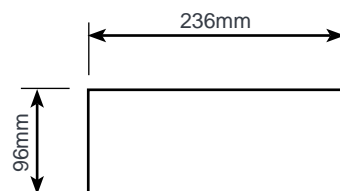

ACABADOS DE LAS MOLDURAS
FINITIONS DE MOULURES / MOULDINGS FINISHES



AL



NO



OL



BA

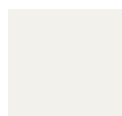

BZ



CA



Méridas en cm / Measurements in centimeters / Mesures en centimètres

H: 73cm

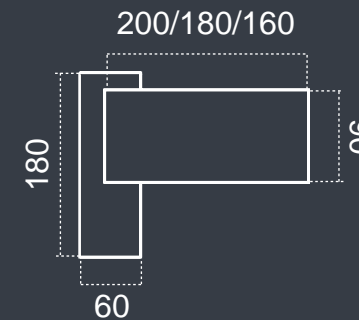
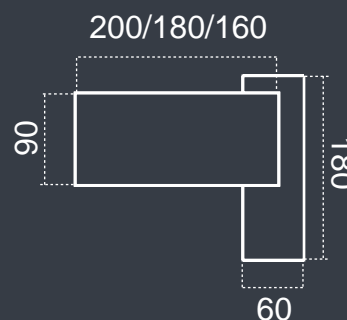
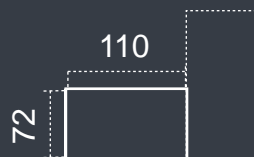
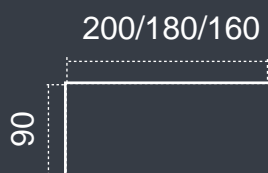



Reunión Líder

Lider Meeting / Réunion Lider

30mm de grosor de tapa postformada fabricada en MDF recubierta con chapa de madera sintética, en acabado mate y barniz. Multitud de colores de madera, formas y medidas, estilo ejecutivo, estilo reunión de plenos y grandes consejos de empresa. La línea Líder dispone de faldones hasta el suelo en todas sus mesas ejecutivas así como la nueva gama de mesas para plenos.

30mm thickness for a postformed MDF desktop covered with a synthetic wood veneer in matt or varnished finish.

Produced in a lot of wood colors, forms and measurements, executive style, plenary meeting style and large company works council style.

The Líder range provides modesty panels until the floor in all its executive desks and a new range of meeting tables for plenary meetings.

30mm d'épaisseur de plateau postformé fabriqué en MDF recouvert d'un bois de placage synthétique en finition matte ou vernie.

Nombreuses couleurs de bois, formes et mesures, style exécutif, style réunion plénière et grand conseil d'entreprise.

La ligne Líder dispose de voiles de fond jusqu'au sol pour tous ses bureaux exécutifs ainsi que d'une nouvelle gamme de tables pour réunions plénières.

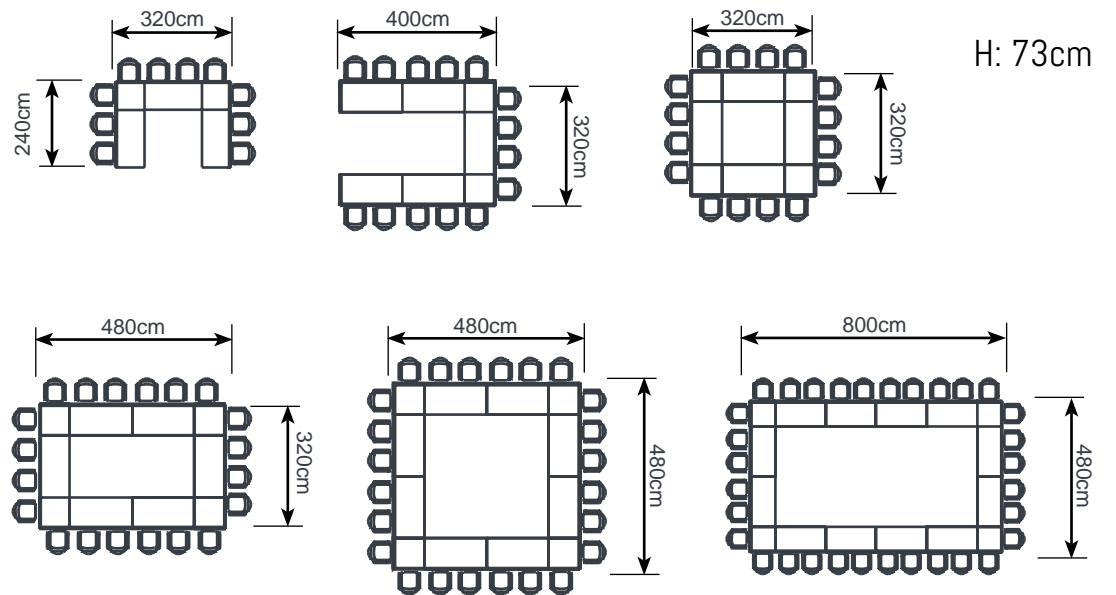
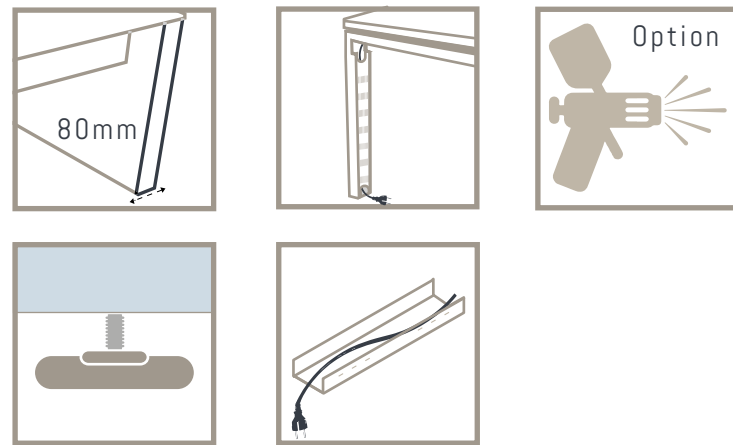

Desarrollado por el equipo de I+D **JGORBE**
 Developed by the JGORBE I + D team / Développé par l'équipe I + D de JGORBE

ACABADOS EN PVC MATE/BARNIZADO
PVC FINISHES MATT/VERNISH / FINITIONS EN PVC MAT/VERNI

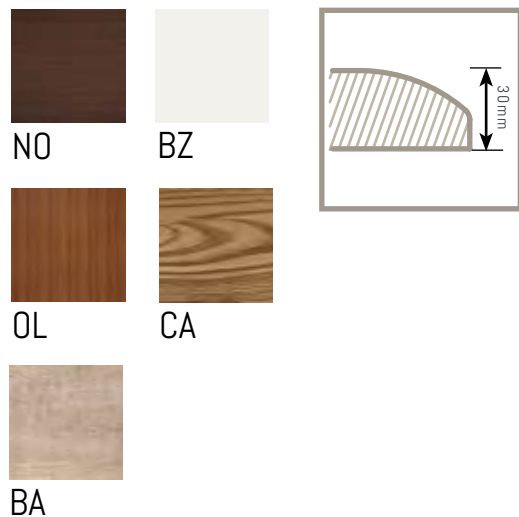

ACABADOS METÁLICOS
METALLIC FINISHES / FINITIONS MÉTALLIQUES

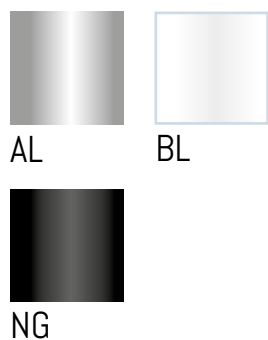

ACABADOS SUB-TAPA
UNDER DESKTOP FINISHES / FINITIONS DU SOUS-PLATEAU



Méridas en cm / Measurements in centimeters / Mesures en centimètres

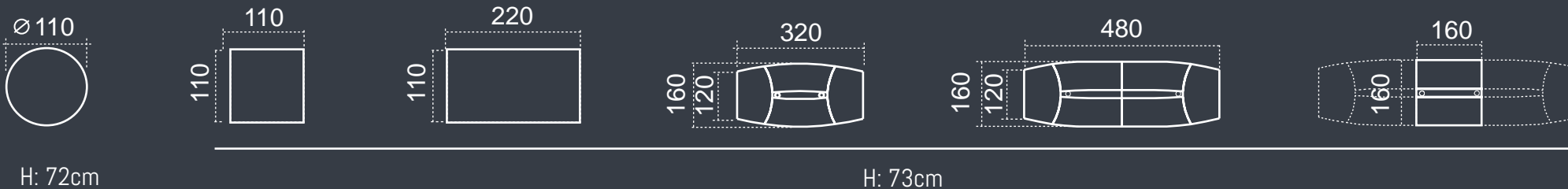



Mesa Ponencia

Ponencia Lider / Ponencia Lider

Fabricada en MDF de tapa postformada de 30mm de grosor, recubierta con chapa de madera sintética, en mate o en barnizado. Múltiples colores. Dispone de faldón hasta el suelo en mesas para plenos.

Desktop produced in postformed MDF of 30mm thickness covered with a synthetic wood veneer in matt or varnished finish. Available in a lot of colours. It has a modesty panel until the floor for the plenary meeting tables.

Tables fabriquées en MDF de plateau postformé en 30mm d'épaisseur, recouvert d'un bois de placage synthétique en finition mate ou vernie. Grand assortiment de couleurs. Dispose d'un voile de fond jusqu'au sol pour les tables de réunions plénières.

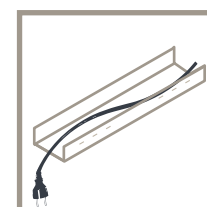
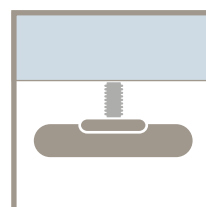
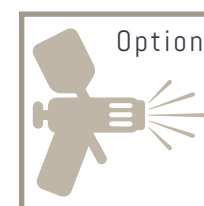
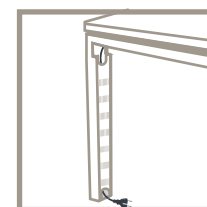
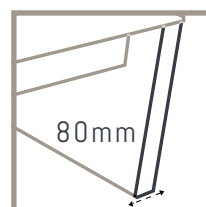

ESTRUCTURA, MESA Y FRONTAL EN PVC MATE/BARNIZADO
 STRUCTURE, DESKTOP AND SIDE CHEEK IN PVC MATT/VARNISHED
 STRUCTURE, PLATEAU ET PARTIE FRONTALE EN PVC MAT/VERNI

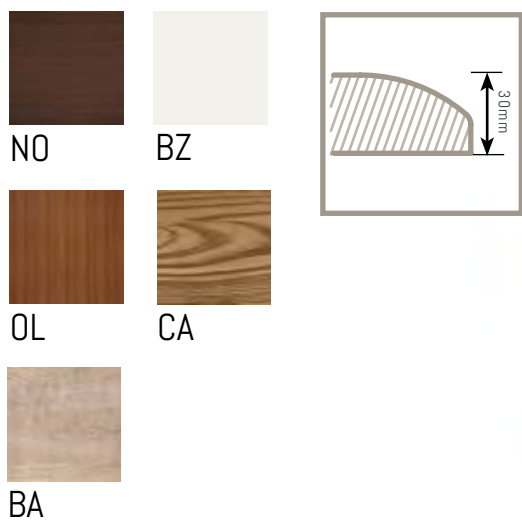

PAS240



PAS100

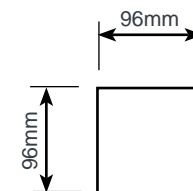
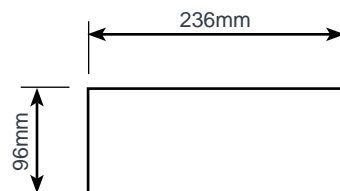

Méridas en cm / Measurements in centimeters / Mesures en centimètres

H: 73cm

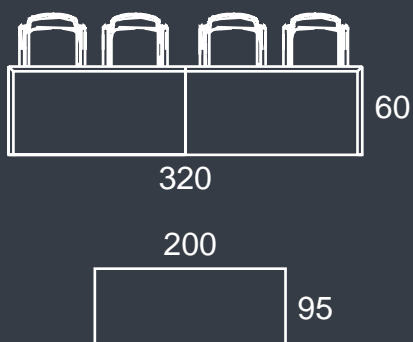
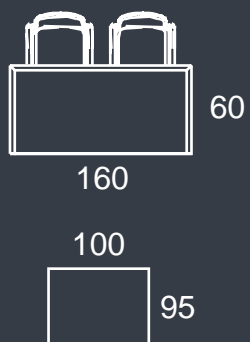



Benelux

Benelux / Bénélux





Benelux

Benelux / Bénélux

Lo clásico sigue siendo actual y que mejor forma para demostrarlo que la serie **Benelux**. Cantos biselados y formas suaves y redondeadas son algunas de las características de esta serie, que se ofrece con sus acabados tanto mate (natural) como barnizados, lo que le da un aspecto diferente a la vez que mejora la resistencia y durabilidad del producto.

Classic is still fashion and no better way to prove it then the **Benelux** range.

Some characteristics of this range are its edges shaped in bevel and its rounded and soft lines in matt (natural) or varnished finishes. The whole give it a different look and, at the same time, improves the resistance and durability of the product.

Le classique est encore à la mode et quelle meilleure façon de le démontrer qu'avec la série **Bénélux**. Arêtes taillées en biseau et lignes adoucies et arrondies sont quelques unes des caractéristiques de cette série dont les finitions, tant en mat (naturel) comme en verni, lui donnent un aspect différent tout en améliorant la résistance et la durabilité du produit.

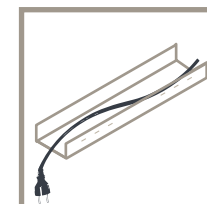
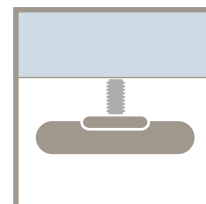
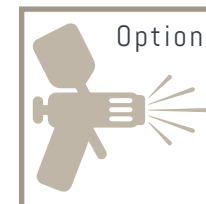
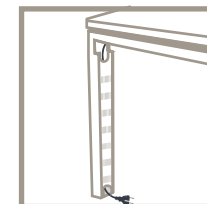
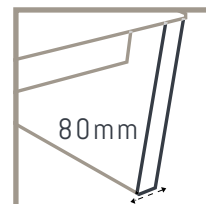

Desarrollado por el equipo de I+D **JGORBE**
 Developed by the JGORBE I + D team / Développé par l'équipe I + D de JGORBE

ACABADOS EN PVC MATE/BARNIZADO
PVC FINISHES MATT/VERNISH / FINITIONS EN PVC MAT/VERNI



NO

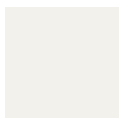

BZ

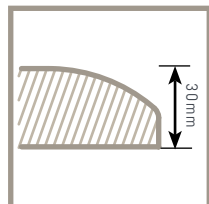

OL



CA



BA

PATÍN PIE
FOOT SKATE / PIED EN FORME



GC



PAS240



PAS100

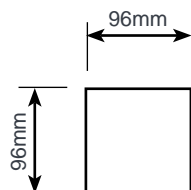
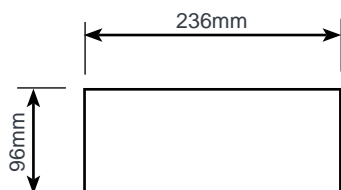

Méridas en cm / Measurements in centimeters / Mesures en centimètres

H: 73cm

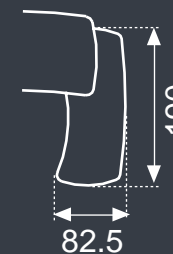
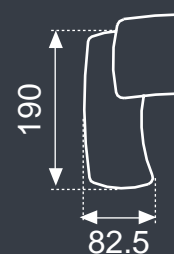
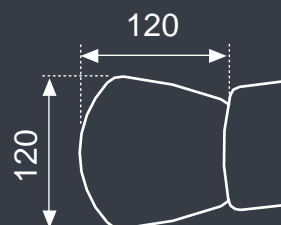
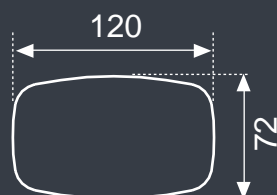
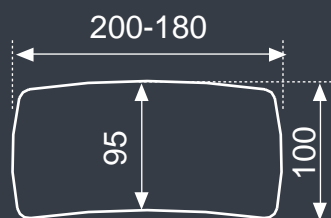



Reunión Benelux

Benelux Meeting / Réunion Bénélux

30mm grosor de tapa postformada fabricada en MDF recubierta con chapa de madera sintética, en acabado mate y barnizado.

Multitud de colores de madera, formas y medidas, en estilo ejecutivo, estilo reunión de plenos y grandes consejos de empresa. La línea Benelux dispone de una variedad casi ilimitada para cubrir todas las necesidades de reunión de altos directivos.

30mm thickness for a postformed MDF desktop covered with a synthetic wood veneer in matt or varnished finish.

Produced in a lot of wood colors, forms and measurements, in executive, plenary meeting and large company works council style.

The Benelux range provides an almost unlimited choice to cover all the meeting requirements of any senior executive team.

30mm d'épaisseur de plateau postformé fabriqué en MDF recouvert d'un bois de placage synthétique en finition matte ou vernie.

Nombreuses couleurs de bois, formes et mesures, style exécutif, style réunion plénière et grand conseil d'entreprise.

La ligne Benelux dispose d'une variété presque illimitée pour couvrir tous les besoins de réunion des cadres supérieurs d'une entreprise.

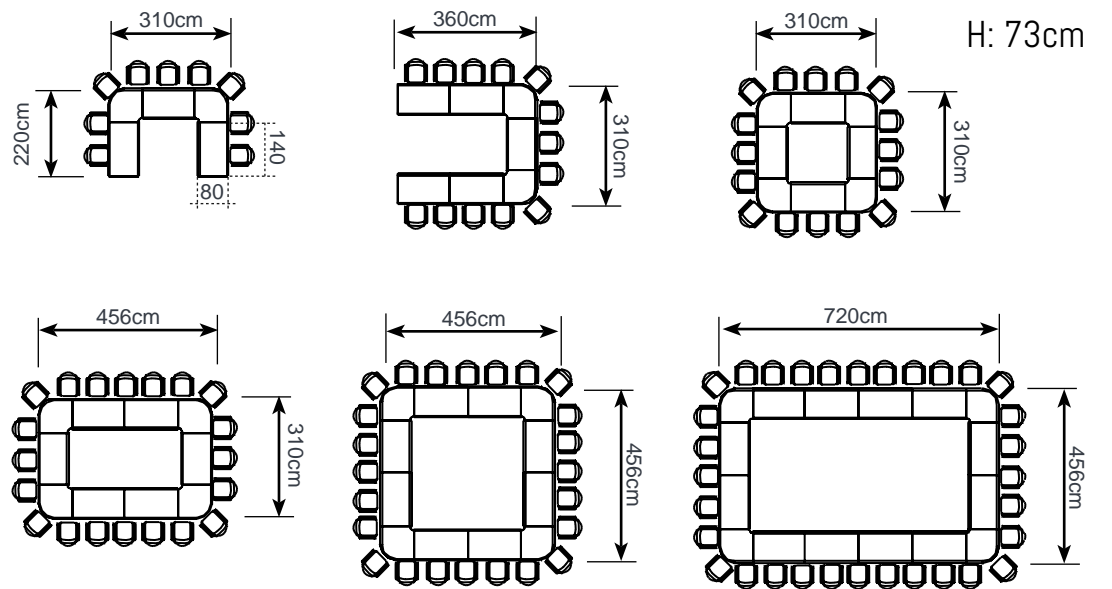
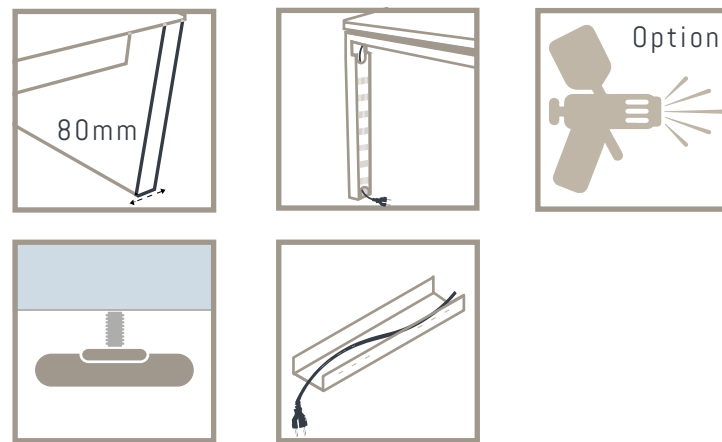

Desarrollado por el equipo de I+D **JGORBE**
 Developed by the JGORBE I + D team / Développé par l'équipe I + D de JGORBE

ACABADOS EN PVC MATE/BARNIZADO
PVC FINISHES MATT/VERNISH / FINITIONS EN PVC MAT/VERNI



NO

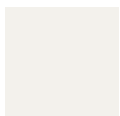

BZ

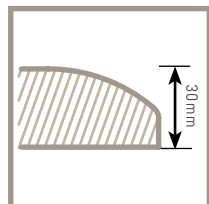

OL



CA



BA



ACABADOS METÁLICOS
METALLIC FINISHES / FINITIONS MÉTALLIQUES



AL



BL



NG



ACABADOS SUB-TAPA
UNDER DESKTOP FINISHES / FINITIONS DU SOUS-PLATEAU



Méridas en cm / Measurements in centimeters / Mesures en centimètres

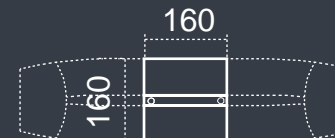
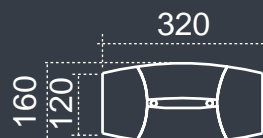
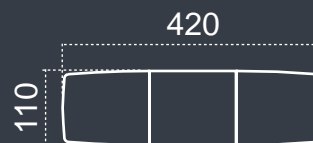
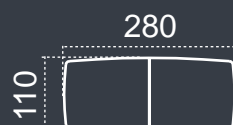
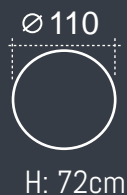

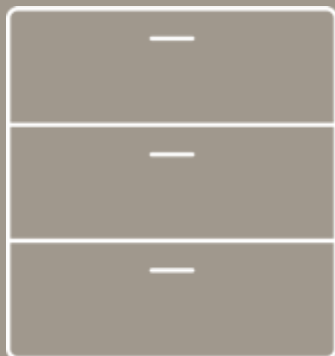

Archivo PVC

Cupboards PVC / Armoires en PVC

Gran combinación de archivadores.
 Laterales y suelo en 19mm de grosor.
 Estantes en 25mm de grosor.
 Trasera en 19mm de grosor.
 Todo en melamina.
 Techo en 30mm de grosor y puertas
 en 19mm de grosor en MDF laminado
 sintético mate o barnizado.

Large assortment of cupboards.
 Side cheeks bottom pieces of 19mm thickness.
 Shelves of 25mm thickness.
 Backsides of 19 mm thickness.
 All pieces are produced in melamine.
 Upper pieces of 30mm thickness and doors of 19mm
 thickness in synthetic laminated MDF in matt or
 varnished finish.

Grand assortiment d'armoires.
 Latéraux et pièces inférieures de 19mm d'épaisseur.
 Étagères de 25mm d'épaisseur et panneaux arrière
 de 19mm d'épaisseur.
 Toutes fabriquées en mélamine.
 Pièces supérieures de 30 mm d'épaisseur et portes de
 19mm d'épaisseur en MDF lamellé synthétique mat ou
 verni.

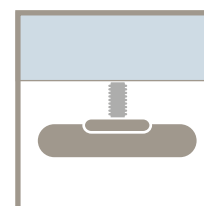
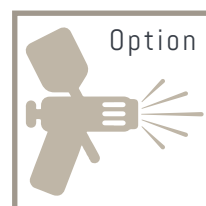

Desarrollado por el equipo de I+D **JGORBE**
 Developed by the JGORBE I + D team / Développé par l'équipe I + D de JGORBE

ACABADOS EN PVC MATE/BARNIZADO

PVC FINISHES MATT/VERNISH / FINITIONS EN PVC MAT/VERNI



NO

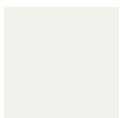

BZ

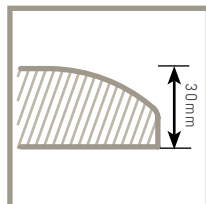

OL



CA



BA



ACABADOS CASCO ARMARIO

BODY CUPBOARD FINISHES / FINITIONS CORPS ARMOIRE



GC

TIRADORES

HANDLES / POIGNÉES



ACABADOS DEL CRISTAL

GLASS FINISHES / FINITIONS EN VERRE



CR-MB



CR-TR

Armarios modulares

Modular cupboards
Armoires modulaires

Vista frontal

Frontal view
Vue frontale



Vista lateral

Side view
Vue latérale

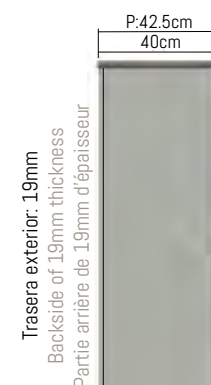

Méridas en cm / Measurements in centimeters / Mesures en centimètres

Mueble auxiliar
Side furniture / Meubles auxiliaires



Mueble Nevera
Fridge furniture / Meuble-frigo

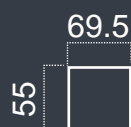

Armarios
Armoires / Cupboards

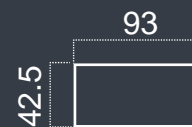

Armarios estrechos
Narrow cupboards / Armoires étroites

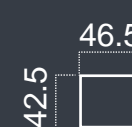

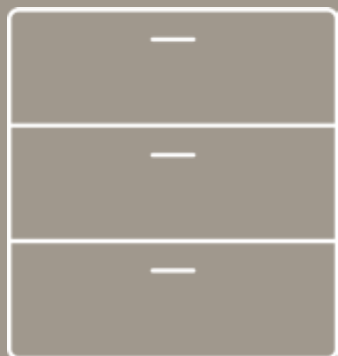

Cajoneras PVC

PVC Filing Cabinets / Caissons PVC

Cajoneras rodantes a la altura de la mesa en combinaciones de 3 cajones o de un cajón y un archivos.

Para ambos modelos, los cajones pueden ser de madera o metálicos.

Acabados en MDF laminado en mate o barnizado.

Rolling filing cabinets coupled under the desktop with metal or wood drawers in two models: 3 drawers or one drawer with one hanging files archive. Finishes in MDF matt or varnished.

Caissons sur roulettes à hauteur du plateau du bureau en combinaison de 3 tiroirs ou d'un seul avec archives (classeur ou à dossiers suspendus) en bois ou en métal. Finitions en MDF mat ou verni.

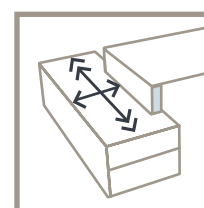
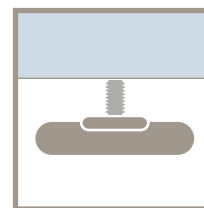
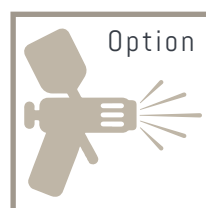

Desarrollado por el equipo de I+D **JGORBE**
 Developed by the JGORBE I + D team / Développé par l'équipe I + D de JGORBE

ACABADOS EN PVC MATE/BARNIZADO

PVC FINISHES MATT/VERNISH / FINITIONS EN PVC MAT/VERNI



NO

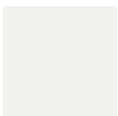

BZ

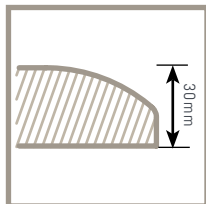

OL



CA



BA

ACABADOS CASCO ARMARIO

BODY CUPBOARD FINISHES / FINITIONS CORPS ARMOIRE



GC

TIRADORES

HANDLES / POIGNÉES



Vista lateral
Side view
Vue latérale

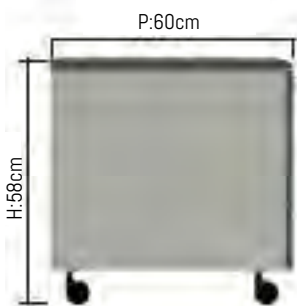

Vista frontal
Frontal view
Vue frontale



Méridas en cm / Measurements in centimeters / Mesures en centimètres

Mueble auxiliar
Side furniture / Meubles auxiliaires



Armarios
Armoires / Cupboards



Armarios estrechos
Narrow cupboards / Armoires étroites

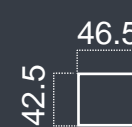



Omega

Omega / Oméga





Omega

Omega / Oméga

La línea **Omega** es un nuevo concepto de despachos para puestos ejecutivos intermedios y de semidirección en los que se mezclan dos materiales: melamina y MDF lacado, con dos tipos de fabricación diferentes que combinan a la perfección: la industrialización en serie y el arte casi olvidado de la ebanistería, pues gran parte del proceso productivo del pie MDF lacado se basa en operaciones totalmente manuales.

Con sus cajoneras y armarios en común con la serie operativas, Omega es una línea atractiva y con personalidad que se adapta a las necesidades de hoy en día.

Omega range is a new desk concept for intermediate and semi-direction posts, in which two materials mix: melamine and varnished MDF and with two different fabrication types which combine perfectly: one in mass production and another in the almost forgotten art of the joinery because a large part of the feet production process in varnished MDF is based on totally hand-made making.

La ligne **Oméga** est un nouveau concept de bureaux pour postes intermédiaires et de semi-direction, dans laquelle se mêlent deux matériaux: mélamine et MDF laqué et deux types différents de fabrication qui combinent à la perfection: celle en série et celle, presque oubliée, de l'art de l'ébénisterie, puisqu'une grande partie du processus de production du pied en MDF laqué se base sur des opérations totalement manuelles.

Avec ses armoires et ses caissons en commun avec la série Opératives, Oméga est une ligne attractive dotée de personnalité qui s'adapte aux besoins d'aujourd'hui.



Desarrollado por el equipo de I+D **JGORBE**
 Developed by the JGORBE I + D team / Développé par l'équipe I + D de JGORBE

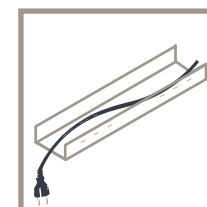
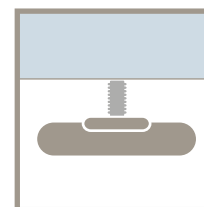
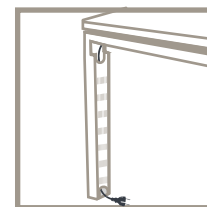
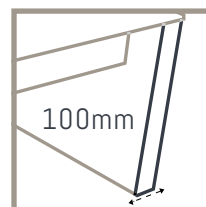

ACABADOS DE MELAMINA
MELAMINE FINISHES / FINITIONS EN MÉLAMINE

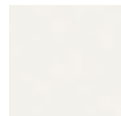

BL



OM

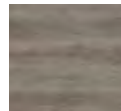
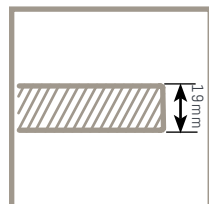

NB

MARCO LATERAL EN DM LACADO
SIDE FRAME IN LACQUED DM / CADRE LATÉRAL EN DM LAQUÉ



AL



BL



NG



AR

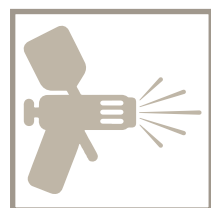

Méridas en cm / Measurements in centimeters / Mesures en centimètres

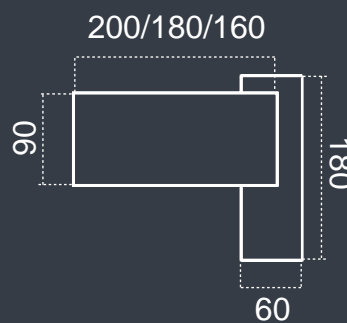
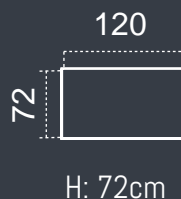
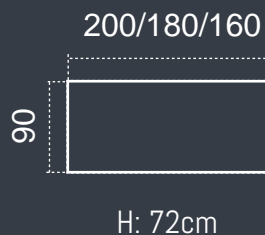

Mueble auxiliar
Side furniture
Meubles auxiliaires

H: 46,5cm

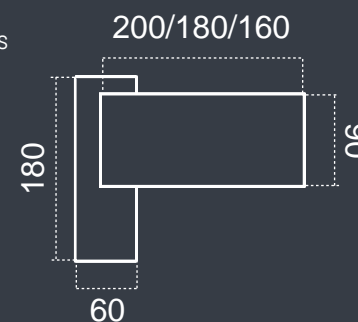



Reunión Omega

Omega Meeting / Réunion Oméga

Tres tipos de mesas: con pies metálicos tipo península, en MDF lacados o en forma de cubo, todas con encimeras en melamina de 19mm grosor. Esa es la carta de presentación de línea de mesas de reunión **Omega**.

Three kinds of tables: with metallic feet peninsula type, in lacquered MDF or with a cube form feet. All desktops are produced in melamine of 19mm thickness. The whole is the cover letter of the **Omega** meeting tables range.

Trois types de tables: avec pieds métalliques genre péninsule, en MDF laqué ou en forme de cube. Les plateaux sont toujours fabriqués en mélamine de 19mm d'épaisseur. L'ensemble est la carte de présentation de la ligne des tables de réunion **Oméga**.

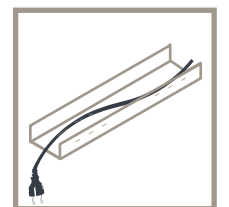
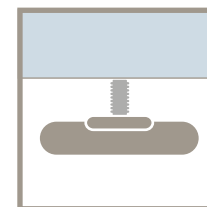
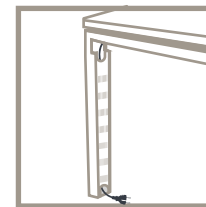
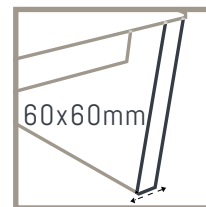

ACABADOS METÁLICOS METALLIC FINISHES / FINITIONS MÉTALLIQUES



AL



BL



NG

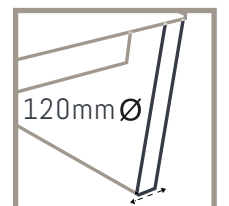

Desarrollado por el equipo de I+D **JGORBE**
Developed by the JGORBE I + D team / Développé par l'équipe I + D de JGORBE

ACABADOS DE MELAMINA

MELAMINE FINISHES / FINITIONS EN MÉLAMINE

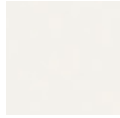

BL



OM

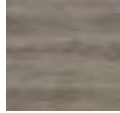
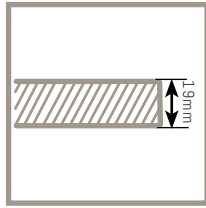

NB

MARCO LATERAL EN DM LACADO

SIDE FRAME IN LACQUED DM / CADRE LATÉRAL EN DM LAQUÉ



AL



BL

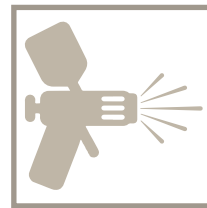

NG



AR

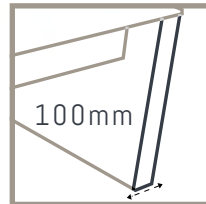

Méridas en cm / Measurements in centimeters / Mesures en centimètres



H: 714cm

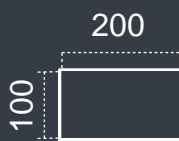

H: 73cm

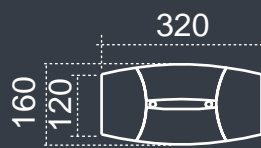

H: 72cm

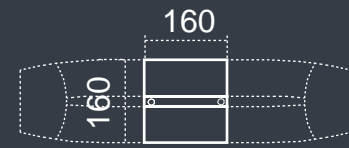
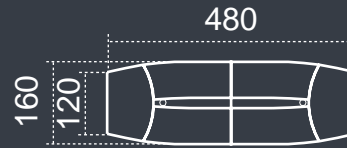



G3:1





G3:1

La serie **G.3** se adapta al nuevo concepto de despachos de semidirección. Es un conjunto moderno y versátil que nos ofrece la posibilidad de crear 81 combinaciones diferentes.

Además la serie se adecúa a la era tecnológica ya que está ideada para ocultar el molesto cableado. La **G.3.1.** es la mesa más sencilla de la serie y una buena solución económica que se adapta a los espacios reducidos.

Sus dimensiones totales son 200/180/160cm x 90cm.

The **G.3** range adapts to the new concept for intermediate direction posts.

This modern and polyvalent range offers the possibility to create 81 different combinations. G.3 is adjusted to the technologic age as it allows to hide the annoying wiring.

The **G.3.1** is the simplest desk of the range and a good and economic solution for the confined spaces to the confined spaces. Its total dimensions are 200/180/160cm X 90cm.

La série **G.3** s'adapte au nouveau concept de bureaux pour les postes intermédiaires de direction.

C'est un ensemble moderne et polyvalent qui offre la possibilité de créer 81 différentes combinaisons.

G.3 s'ajuste à l'ère technologique puisqu'elle permet de cacher le câblage si inoportun.

La **G.3.1** est la table la plus simple de la série et une bonne solution économique qui s'adapte aux espaces réduits. Ses dimensions totales sont 200/180/160cm X 90cm.



Desarrollado por **LORENA HERRERO**

Developed by LORENA HERRERO / Développé par LORENA HERRERO

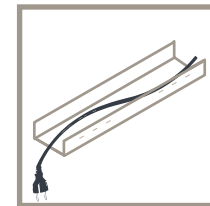
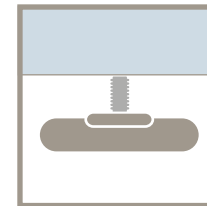
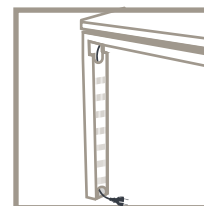
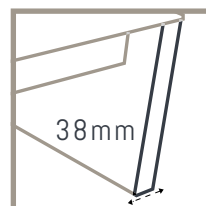



ACABADOS DE MELAMINA
MELAMINE FINISHES / FINITIONS EN MÉLAMINE

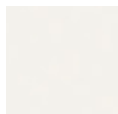

BL



OM

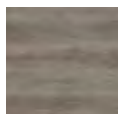
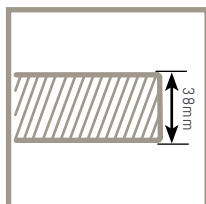

NB

PERFECT SENSE ANTIHUELLA / NON-MARKING / ANTI-EMPREINTES



FALDONES ESTRUCTURALES
STRUCTURAL MODESTY PANELS
VOILES DE FOND STRUCTURELS

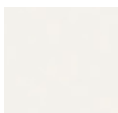

BP



AR



NP

Méridas en cm / Measurements in centimeters / Mesures en centimètres

Mesa
Desk / Bureau

200/180/160

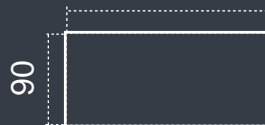

H: 73cm

Mueble auxiliar
Side furniture / Meubles auxiliaires

82.5



H: 55cm



G3:2

La serie **G.3** se adapta al nuevo concepto de despachos de semidirección.

Es un conjunto moderno y versátil que nos ofrece la posibilidad de crear 81 combinaciones diferentes. Además la serie se adecúa a la era tecnológica ya que está ideada para ocultar el molesto cableado. Como en la mesa asimétrica **G.3.2** que cuenta con un pie hueco con "top access" cuya finalidad es la de esconder el cableado de los aparatos electrónicos.

Sus dimensiones totales son 220/200/180cm x 90cm.

The **G.3** range adapts to the new concept for intermediate direction posts.

This modern and polyvalent range offers the possibility to create 81 different combinations.

G.3 is adjusted to the technologic age as it allows to hide the annoying wiring like the asymmetric table **G.3.2**, which has a hollow feet with "top access" to the wiring of the electronic devices.

Its total dimensions are 220/200/180cm X 90cm.

La série **G.3** s'adapte au nouveau concept de bureaux pour les postes intermédiaires de direction.

C'est un ensemble moderne et polyvalent qui offre la possibilité de créer 81 différentes combinaisons.

G.3 s'ajuste à l'ère technologique puisqu'elle permet de cacher le câblage si inopportun, comme pour la table asymétrique **G.3.2** qui à un pied creux avec "top access" dont la finalité est de cacher le câblage des appareils électroniques.

Ses dimensions totales sont 220/200/180cm X 90cm.



Desarrollado por **LORENA HERRERO**

Developed by LORENA HERRERO / Développé par LORENA HERRERO

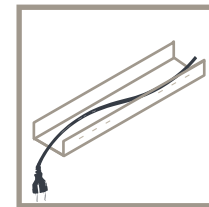
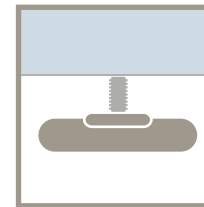
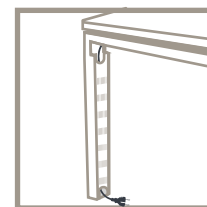
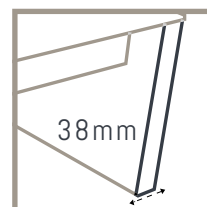



ACABADOS DE MELAMINA
MELAMINE FINISHES / FINITIONS EN MÉLAMINE

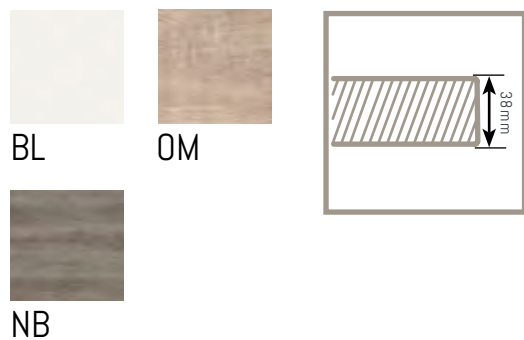

PERFECT SENSE ANTIHUELLA / NON-MARKING / ANTI-EMPREINTES



FALDONES ESTRUCTURALES
STRUCTURAL MODESTY PANELS
VOILES DE FOND STRUCTURELS

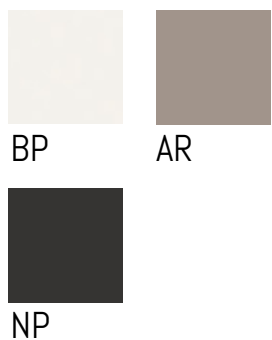

Méridas en cm / Measurements in centimeters / Mesures en centimètres

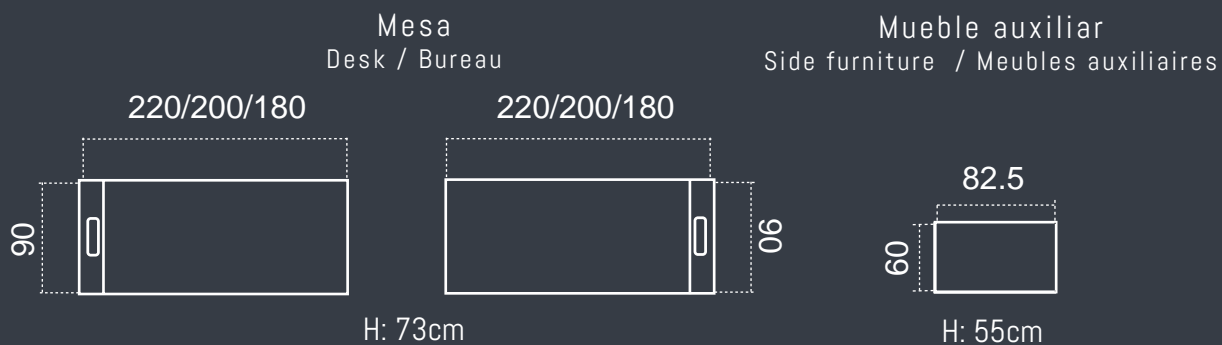



G3:3





G3:3

La G.3.3 es una mesa completa con ala que permite que el puesto de trabajo sea más amplio y cómodo. Cuenta también con el mismo pie hueco que el modelo G.3.2. para ocultar el cableado. Sus dimensiones totales son 220/200/180cm x 90cm y el ala mide 180cm.

The G.3.3 is a complete desk with wing which allows the work post to be larger and most comfortable. In addition it has the same hollow foot as the model G.3.2 to hide the wiring. Its total dimensions are 220/200/180cmX 90cm and its wing measures 180cm.

Le G.3.3 est un bureau complet avec retour qui permet que le poste de travail soit plus ample et commode. En plus il a le même pied creux que le modèle G.3.2 pour cacher le câblage. Ses dimensions totales sont 220/200/180cm X 90cm et le retour mesure 180cm.

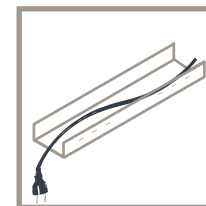
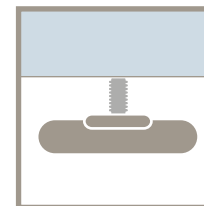
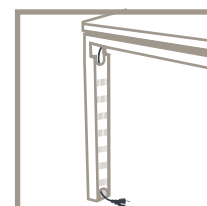
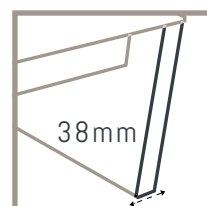

Desarrollado por **LORENA HERRERO**
 Developed by LORENA HERRERO / Développé par LORENA HERRERO



ACABADOS DE MELAMINA
MELAMINE FINISHES / FINITIONS EN MÉLAMINE

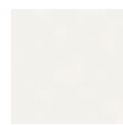

BL



OM

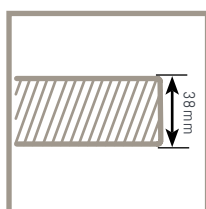

NB

PERFECT SENSE ANTIHUELLA / NON-MARKING / ANTI-EMPREINTES



FALDONES ESTRUCTURALES
STRUCTURAL MODESTY PANELS
VOILES DE FOND STRUCTURELS



BP



AR



NP

Méidas en cm / Measurements in centimeters / Mesures en centimètres

Mesa / Desk / Bureau

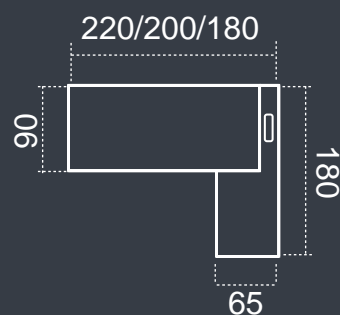

H: 73cm

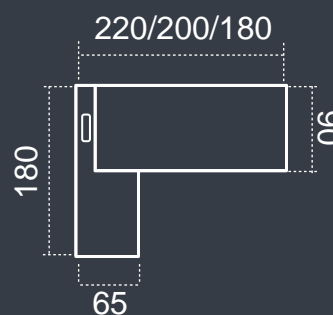

Mueble auxiliar
Side furniture / Meubles auxiliaires

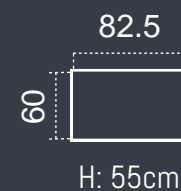



Reunión G3

G3 Meeting / Réunion G3

La serie **G.3** se adapta al nuevo concepto de despachos de semidirección. Es un conjunto moderno y versátil que nos ofrece la posibilidad de crear 81 combinaciones diferentes. Además la serie se adecúa a la era tecnológica ya que está ideada para ocultar el molesto cableado.

The **G.3** range adapts to the new concept for intermediate direction posts. This modern and polyvalent range offers the possibility to create 81 different combinations. G.3 is adjusted to the technologic age as it allows to hide the annoying wiring.

La série **G.3** s'adapte au nouveau concept de bureaux pour les postes intermédiaires de direction. C'est un ensemble moderne et d'une grande versatilité qui offre la possibilité de créer 81 différentes combinaisons. G.3 s'ajuste à l'ère technologique puisqu'elle permet de cacher le câblage si inoportun.

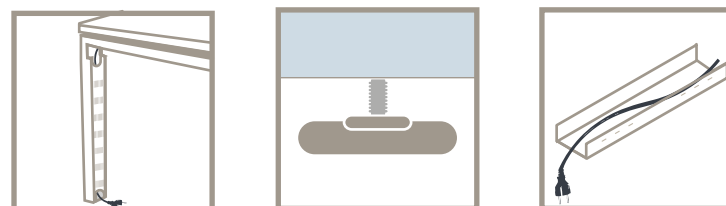

Desarrollado por **LORENA HERRERO**
 Developed by LORENA HERRERO / Développé par LORENA HERRERO

ACABADOS DE MELAMINA

MELAMINE FINISHES / FINITIONS EN MÉLAMINE

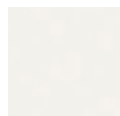

BL



OM

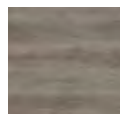
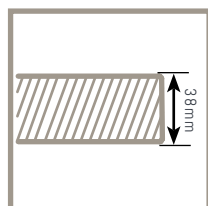

NB

ACABADOS METÁLICOS

METALLIC FINISHES / FINITIONS MÉTALLIQUES



AL



BL



NG

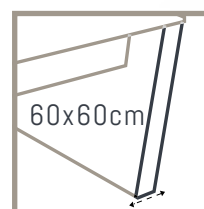

Méidas en cm / Measurements in centimeters / Mesures en centimètres

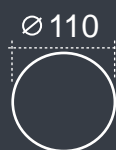

H: 72cm

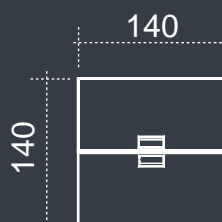

H: 73cm

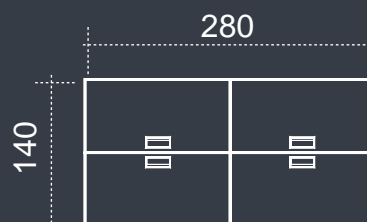

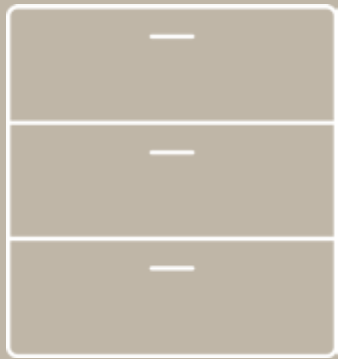

Archivo G3

Cupboards G3 / Armoires G3

Gran combinación de archivadores.
Laterales, techo y trasera exterior de
19mm de grosor.
Estantes de 25mm de grosor.
Todos ellos para la serie de melamina.

Large assortment of cupboards.
Side cheeks, backsides and top pieces of 19mm
thickness.
Shelves in 25mm thickness.
All pieces for the melamine range.

Grand assortiment d'armoires.
Latéraux, arrières extérieurs et pièces supérieures
d'une épaisseur de 19mm.
Étagères d'une épaisseur de 25mm.
Toutes les pièces pour la série en mélamine.

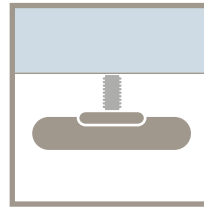

Desarrollado por **LORENA HERRERO**
Developed by LORENA HERRERO / Développé par LORENA HERRERO

ACABADOS DE MELAMINA PARA CASCOS Y PUERTAS

FINISHES IN MELAMINE FOR BODIES AND DOORS

FINITIONS EN MÉLAMINE POUR LES CORPS ET LES PORTES

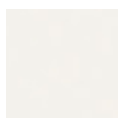

BL



OM

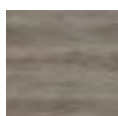
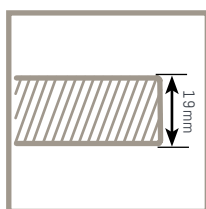

NB

ACABADOS BIMELAMINA SUPERMATE ANTIHUELLA PARA PUERTAS Y FRENTES

TWOMELAMINE SUPERMAT NON-MARKING

FINISHES FOR DOORS AND FRONT SIDES

FINITIONS EN BI-MÉLAMINE SUPERMATTE

ANTI-EMPREINTES POUR PORTES ET FRONTAUX

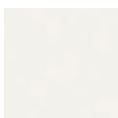

BP



AR



NP



Armarios modulares
Modular cupboards
Armoires modulaires

Vista frontal
Frontal view
Vue frontale

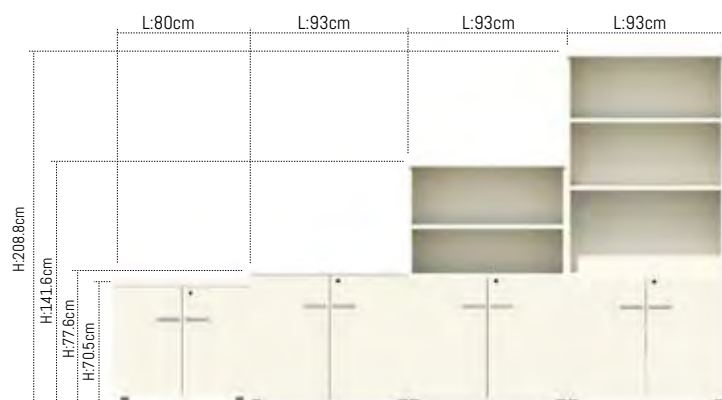

Vista lateral
Side view
Vue latérale

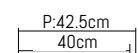

Trasera exterior: 19mm
Backside of 19mm thickness
Partie arrière de 19mm d'épaisseur

Méridas en cm / Measurements in centimeters / Mesures en centimètres

Mueble auxiliar
Side furniture / Meubles auxiliaires



Armarios
Cupboards / Armoires

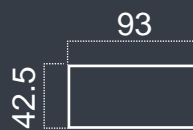

Armarios estrechos
Narrow cupboards / Armoires étroites

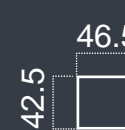



A modern office desk with a light wood finish and a silver adjustable pedestal, set in a high-rise office with a city view. The desk is positioned in front of a large window overlooking a dense urban landscape. A black office chair is visible on the left, and a stack of books and a laptop are on the desk. The word "Level" is overlaid in white text on a dark grey background in the upper right corner.

Level



Level

Reunión Level

Level Meeting / Réunion Level

La serie **Level** tiene mesas elevables electrónicamente en altura lo que les permite adaptarse a las necesidades de nuestros clientes con una versatilidad y flexibilidad nunca vista antes.

The **Level** range is composed with our electronically adjustable height tables to allow to our costumers a versatility and flexibility never seen before.

La série **Level** est faite de tables réglables électroniquement en hauteur ce qui leur permet de s'adapter aux besoins de nos clients et leur donne une versatilité et une flexibilité jamais vue auparavant.

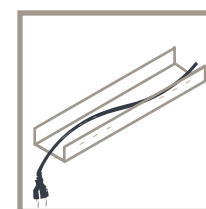
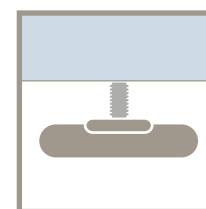
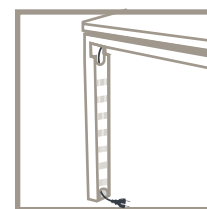
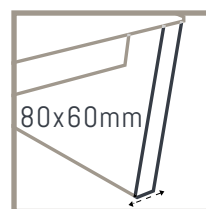

Desarrollado por el equipo de I+D **JGORBE**
Developed by the JGORBE I + D team / Développé par l'équipe I + D de JGORBE

ACABADOS MELAMINA

MELAMINE FINISHES / FINITIONS EN MÉLAMINE

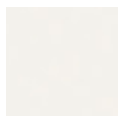

BL



OM

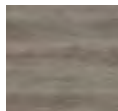
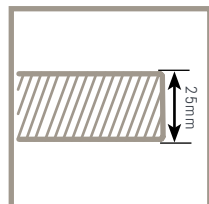

NB



GC



AC



ACABADOS METÁLICOS

METALLIC FINISHES / FINITIONS MÉTALLIQUES



AL



Méridas en cm / Measurements in centimeters / Mesures en centimètres

180/160/140/120

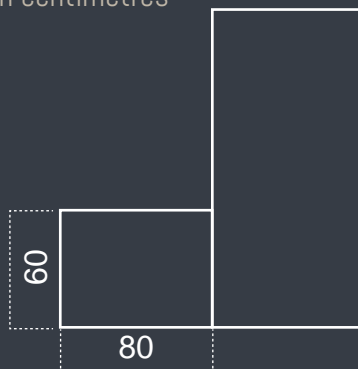

H: 68,5 / 129 cm

Reunión / Meeting / Réunion





Bench Level

La serie **Level** tiene mesas elevables electrónicamente en altura lo que les permite adaptarse a las necesidades de nuestros clientes con una versatilidad y flexibilidad nunca vista antes.

The **Level** range is composed with our electronically adjustable height tables to allow to our costumers a versatility and flexibility never seen before.

La série **Level** est faite de tables réglables électroniquement en hauteur ce qui leur permet de s'adapter aux besoins de nos clients et leur donne une versatilité et une flexibilité jamais vue auparavant.

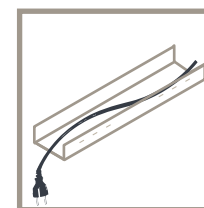
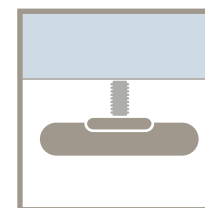
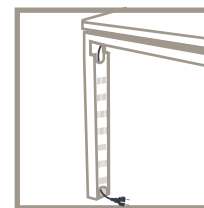
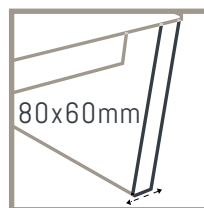

Méidas en cm / Measurements in centimeters /
Mesures en centimètres

160x160

ALGUNOS EJEMPLOS DE COMPOSICIONES
PREGUNTAR EN FÁBRICA

SOME COMPOSITIONS EXAMPLES
ASK FACTORY

QUELQUES EXEMPLES DE COMPOSITIONS
DEMANDER EN FABRIQUE

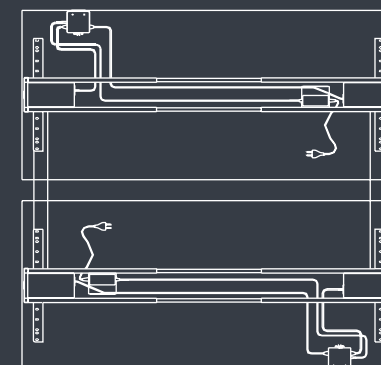

Desarrollado por el equipo de I+D **JGORBE**
Developed by the JGORBE I + D team / Développé par l'équipe I + D de JGORBE

ACABADOS MELAMINA

MELAMINE FINISHES / FINITIONS EN MÉLAMINE

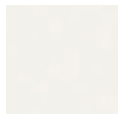

BL



OM

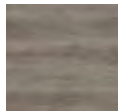
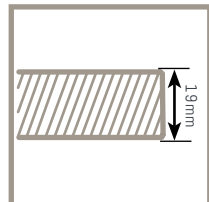

NB

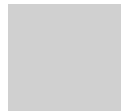

GC



AC



ACABADOS METÁLICOS

METALLIC FINISHES / FINITIONS MÉTALLIQUES



AL



BL

160x320

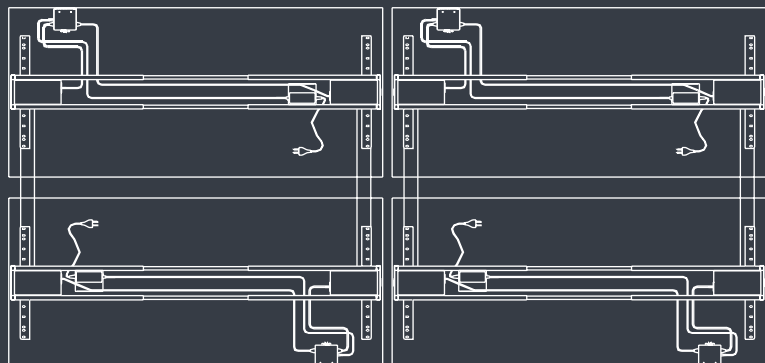

160x480

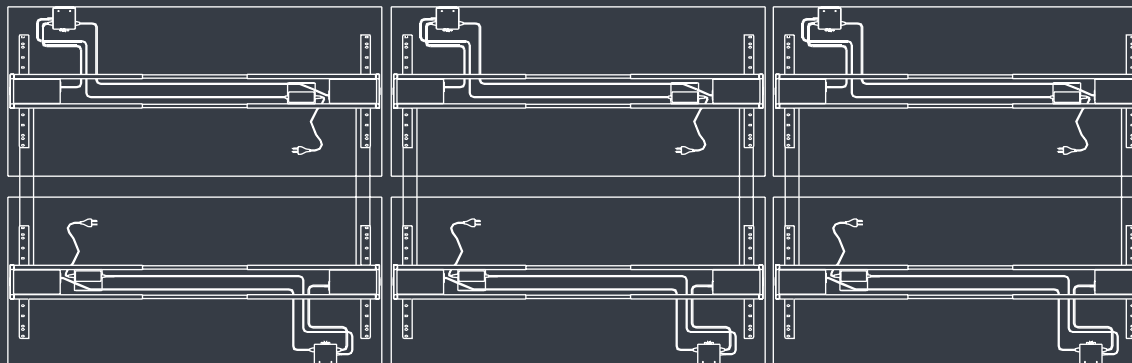

H: 68,5 / 129cm



Skala





Skala

Reunión Skala

Skala Meeting / Réunion Skala

La serie *Skala* tiene una estructura de diseño moderno y ligero pero muy resistente, ya que incluye de serie 2 vigas de refuerzo. Opcionalmente se puede añadir al despacho o mesa un faldón decorativo de melamina así como diferentes accesorios metálicos lo que hace a la serie multifuncional.

The *Skala* range has a structure of modern and light design but also very heavy-duty because it includes two standard reinforcement crosspieces. Optionnally you can add a melamine modesty panel and different metallic accesories which made the range multifunctional.

La série *Skala* a une structure de design moderne et légère mais très résistante puisqu'elle inclut de série 2 poutres de renfort. Optionnellement on peut lui ajouter un voile de fond de mélamine ainsi que différents accessoires métalliques ce qui en fait une série multifonctionnelle.

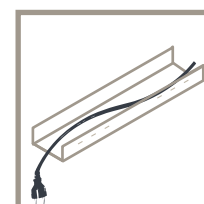
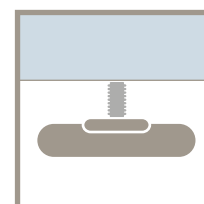
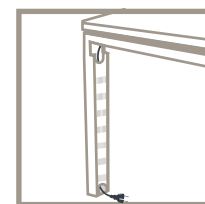
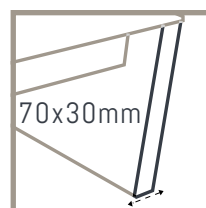

Reunión Skala / Skala Meeting / Réunion Skala

220/200/180/160/140

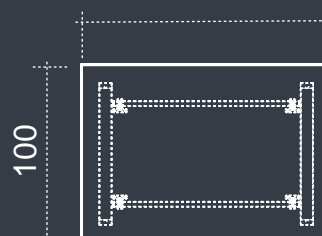

H: 73cm



Desarrollado por el equipo de I+D **JGORBE**
Developed by the JGORBE I + D team / Développé par l'équipe I + D de JGORBE

ACABADOS MELAMINA

MELAMINE FINISHES / FINITIONS EN MÉLAMINE

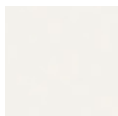

BL



OM

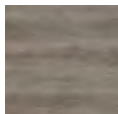
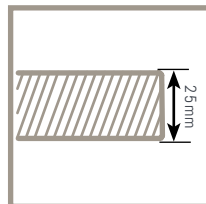

NB



GC



AC



ACABADOS METÁLICOS

METALLIC FINISHES / FINITIONS MÉTALLIQUES



AL



BL



NG

Méridas en cm / Measurements in centimeters / Mesures en centimètres

H: 73cm

200/180/160/140/120



120



100/80



180-160

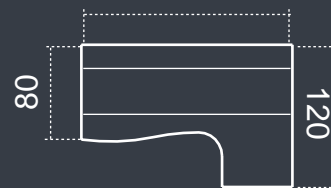

180-160

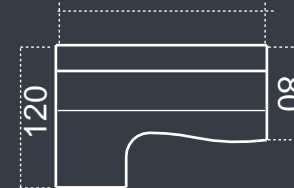



Bench Skala

Con la versión de **Bench Skala** subimos a un nivel más técnico con estructuras compartidas disponibles en diferentes largos y pies centrales retranqueados que la dotan de una gran comodidad para el usuario y nos permite jugar desde los puestos estandarizados de 2-4-6 usuarios hasta el número que la imaginación o el espacio físico de cada instalación permita.

This version of **Bench Skala** reaches a more technical level, with common structures available in different lengths and back central legs for a better comfort, it allows us also to play from 2-4-6 users to so much users as imagination and each installation delimits in physical space.

Cette version de **Bench Skala** s'élève à un niveau plus technique, avec des structures communes disponibles en différentes longueurs et des pieds centraux en retrait pour une meilleure commodité. La série nous permet de jouer entre les 2-4-6 usagers et autant d'usagers que l'imagination et l'espace physique de chaque installation permette.

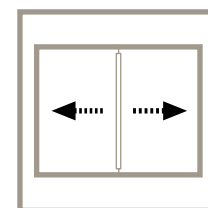
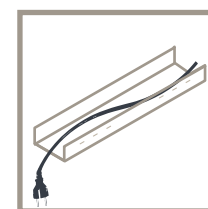
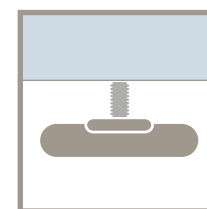
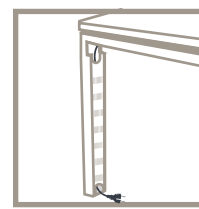
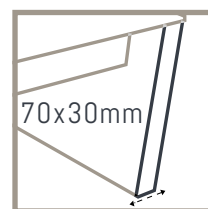

ACABADOS MELAMINA
MELAMINE FINISHES / FINITIONS EN MÉLAMINE



BL OM



NB GC



AC

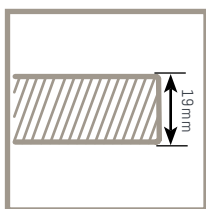

ACABADOS METÁLICOS
METALLIC FINISHES / FINITIONS MÉTALLIQUES



AL BL



NG

Méridas en cm / Measurements in centimeters / Mesures en centimètres

H: 72cm

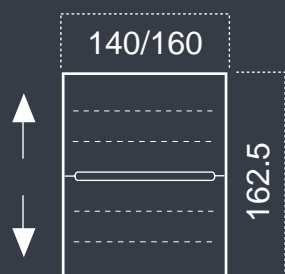



Pórtico

Portico / Portico





Pórtico

Portico / Portico

La serie **Pórtico** tiene una estructura de diseño moderno y ligero pero muy resistente ya que incluye de serie 2 vigas de refuerzo.
Opcionalmente se le puede añadir un faldón decorativo de melamina así como diferentes accesorios metálicos lo que hace que la serie sea multifuncional.

The **Portico** range has a structure of modern and light design but also very heavy-duty because it includes two reinforcement crosspieces.
Optionally you can add it a melamine modesty panel and different metallic accessories which made the range multifunctional.

La série **Portico** a une structure de design moderne et légère mais très résistante puisqu'elle inclut de série 2 poutres de renfort.
Optionnellement on peut lui ajouter un voile de fond de mélamine ainsi que différents accessoires métalliques ce qui fait que la série soit multifonctionnelle.



DISPONIBLE KIT DE REGULACIÓN DE ALTURA
AVAILABLE HEIGHT ADJUSTABLE KIT
DISPONIBLE KIT RÉGULABLE EN HAUTEUR

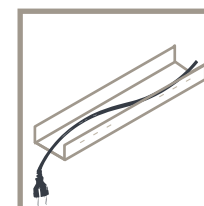
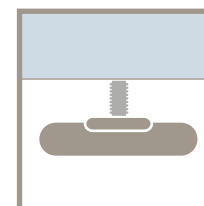
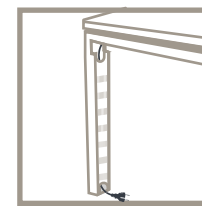
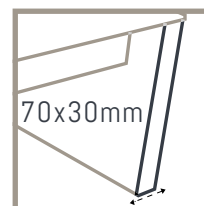

Desarrollado por el equipo de I+D **JGORBE**
Developed by the JGORBE I + D team / Développé par l'équipe I + D de JGORBE

ACABADOS MELAMINA

MELAMINE FINISHES / FINITIONS EN MÉLAMINE



BL



OM

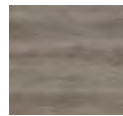

NB



GC



AC

ACABADOS METÁLICOS

METALLIC FINISHES / FINITIONS MÉTALLIQUES



AL



BL



NG

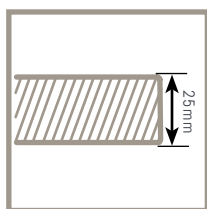

Méridas en cm / Measurements in centimeters / Mesures en centimètres

H: 73cm

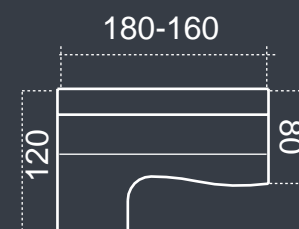
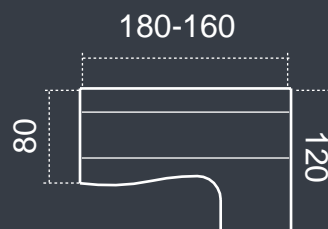
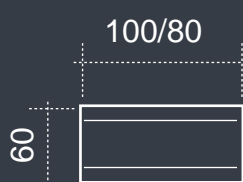
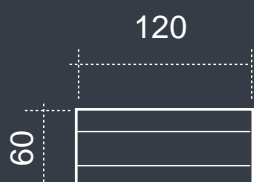





Bench Pórtico

Bench Portico / Bench Portico



Bench Pórtico

Bench Portico / Bench Portico

Con la versión de **Bench Pórtico** subimos a un nivel más técnico con estructuras compartidas disponibles en diferentes largos y pies centrales retranqueados que la dotan de una gran comodidad para el usuario y nos permite jugar desde puestos estandarizados de 2-4-6 usuarios hasta el número que la imaginación o el espacio físico de cada instalación permita.

This version of **Bench Portico** reaches a more technical level, with common structures available in different lengths and back central legs for a better comfort, it allows us also to play from 2-4-6 users to so much users as imagination and each installation space delimits.

Cette version de **Bench Portico** s'élève à un niveau plus technique, avec des structures communes disponibles en différentes longueurs et des pieds centraux en retrait pour une meilleure commodité qui nous permet de jouer entre les 2-4-6 usagers et autant d'usagers que l'imagination et l'espace physique de chaque installation permette.

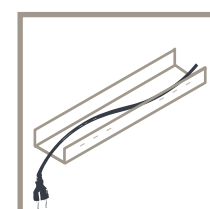
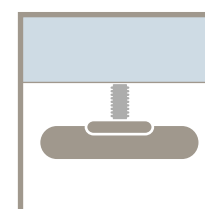
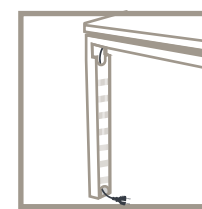
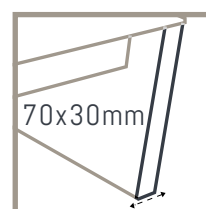
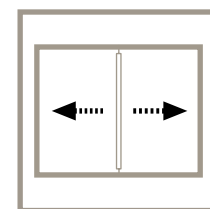

Desarrollado por el equipo de I+D **JGORBE**
 Developed by the JGORBE I + D team / Développé par l'équipe I + D de JGORBE

ACABADOS MELAMINA
MELAMINE FINISHES / FINITIONS EN MÉLAMINE



BL OM



NB GC



AC

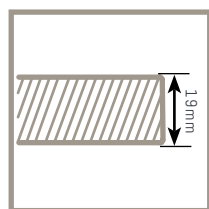

ACABADOS METÁLICOS
METALLIC FINISHES / FINITIONS MÉTALLIQUES



AL BL



NG



Méridas en cm / Measurements in centimeters / Mesures en centimètres

H: 72cm

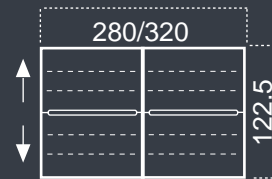
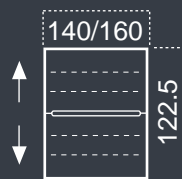
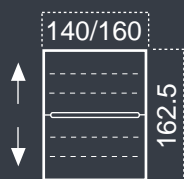



Reunión Pórtico

Portico Meeting / Réunion Portico





Reunión Pórtico

Portico Meeting / Réunion Portico

Con la versión de **Pórtico** subimos a un nivel más técnico con estructuras compartidas disponibles en diferentes largos y pies centrales retranqueados que la dotan de una gran comodidad para el usuario y nos permite jugar desde puestos estandarizados de 2-4-6 usuarios hasta el número que la imaginación o el espacio físico de cada instalación permita.

This version of **Portico** reaches a more technical level, with common structures available in different lengths and back central legs for a better comfort, it allows us also to play from 2-4-6 users to so much users as imagination and each installation delimits.

Cette version de **Portico** s'élève à un niveau plus technique, avec des structures communes disponibles en différentes longueurs et des pieds centraux en retrait pour une meilleure commodité qui nous permet de jouer entre les 2-4-6 usagers et autant d'usagers que l'imagination et l'espace physique de chaque installation permette.

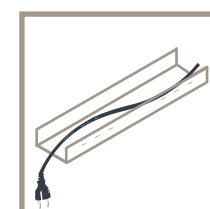
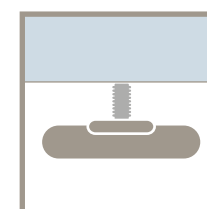
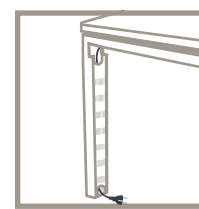
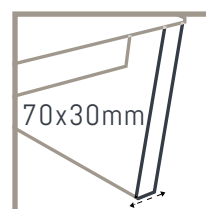
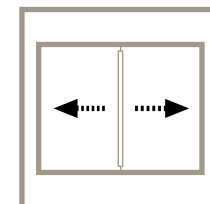

Reunión Pórtico / Portico Meeting / Réunion Portico

220/200/180/160/140

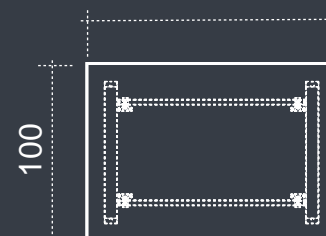

H: 73cm



Desarrollado por el equipo de I+D **JGORBE**
 Developed by the JGORBE I + D team / Développé par l'équipe I + D de JGORBE

ACABADOS MELAMINA

MELAMINE FINISHES / FINITIONS EN MÉLAMINE

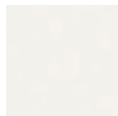

BL



OM

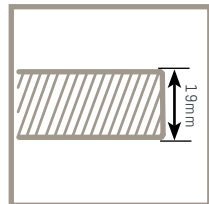

NB



GC



AC

ACABADOS METÁLICOS

METALLIC FINISHES / FINITIONS MÉTALLIQUES



AL



BL



NG



Méidas en cm / Measurements in centimeters / Mesures en centimètres

H: 73cm

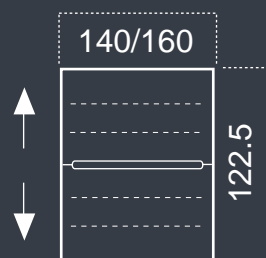



Atrio





Atrio

Reunión Atrio

Atrio Meeting / Réunion Atrio

La serie **Atrio** tiene una estructura de diseño moderno y ligero, pero muy resistente, ya que incluye de serie 2 vigas de refuerzo. Opcionalmente se le puede añadir un faldón decorativo de melamina así como diferentes accesorios metálicos lo que hace que la serie sea multifuncional.

The **Atrio** range has a structure of modern and light design but also very heavy-duty because it includes two reinforcement crosspieces. Optionnally you can add it a melamine modesty panel and different metallic accesories which made the range multifunctional.

La série **Atrio** a une structure de design moderne et légère mais très résistante puisqu'elle inclut de série 2 poutres de renfort. Optionnellement on peut ajouter un voile de fond de mélamine ainsi que différents accessoires métalliques ce qui fait que la série soit multifonctionnelle

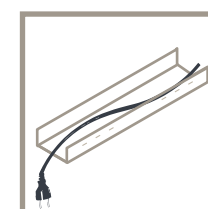
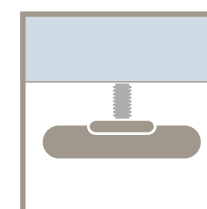
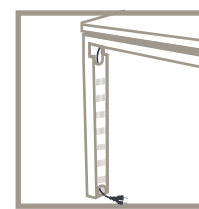
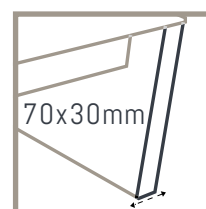
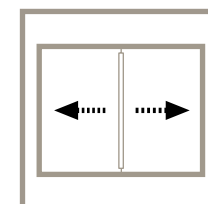

Reunión Atrio / Atrio Meeting / Réunion Atrio

220/200/180/160/140

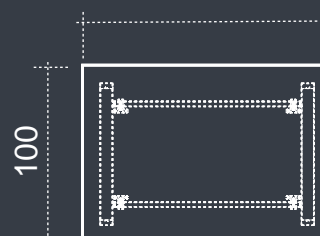

H: 73cm



Desarrollado por el equipo de I+D **JGORBE**
 Developed by the JGORBE I + D team / Développé par l'équipe I + D de JGORBE

ACABADOS MELAMINA

MELAMINE FINISHES / FINITIONS EN MÉLAMINE



BL



OM

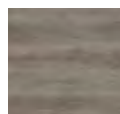
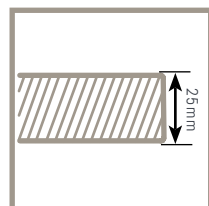

NB



GC



AC

ACABADOS METÁLICOS

METALLIC FINISHES / FINITIONS MÉTALLIQUES



AL



BL



NG



Méridas en cm / Measurements in centimeters / Mesures en centimètres

H: 73cm

200/180/160/140/120

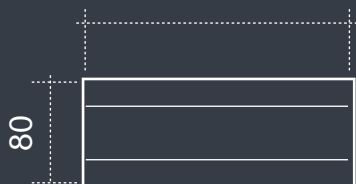

120



100/80



180-160

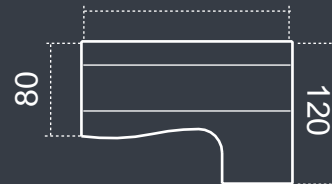

180-160

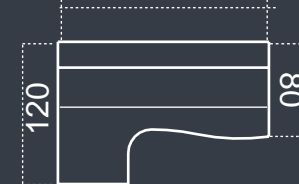



Bench Atrio

En esta versión de **Bench Atrio** subimos a un nivel más técnico con estructuras compartidas en bench de 2-4-6 puestos y pies centrales retranqueados para una mayor comodidad del usuario.

This version of **Bench Atrio** reaches a more technical level with common structures in bench of 2-4-6 places and back central legs for a better users' comfort.

Cette version de **Bench Atrio** s'élève à un niveau plus technique avec des structures communes en bench de 2-4-6 postes et des pieds centraux en retrait pour une meilleure commodité des usagers.

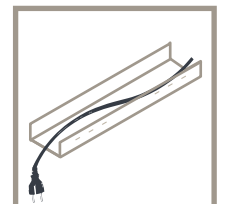
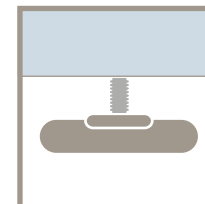
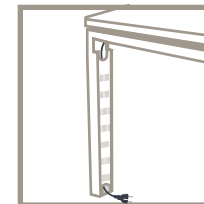
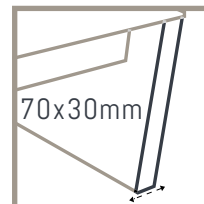
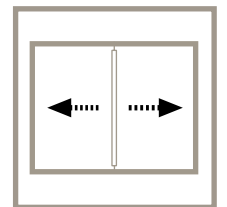
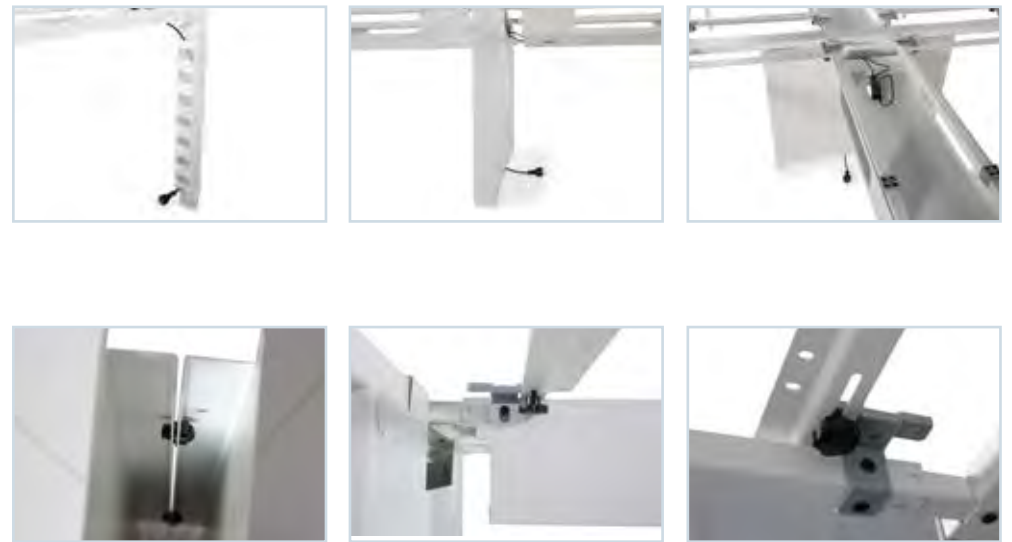

Desarrollado por el equipo de I+D **JGORBE**
 Developed by the JGORBE I + D team / Développé par l'équipe I + D de JGORBE

ACABADOS MELAMINA

MELAMINE FINISHES / FINITIONS EN MÉLAMINE

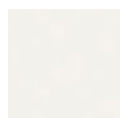

BL



OM

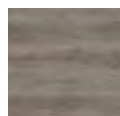
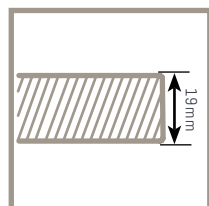

NB



GC



AC

ACABADOS METÁLICOS

METALLIC FINISHES / FINITIONS MÉTALLIQUES



AL



BL



NG



Méridas en cm / Measurements in centimeters / Mesures en centimètres

H: 72cm

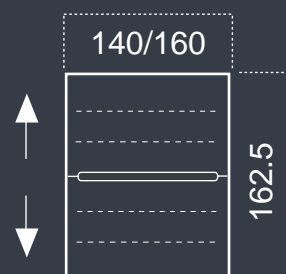



Carving





Carving

El pié **Carving** está equipado con una viga extensible electrificable. Tiene una estructura de carcasa metálica y un alma pasacables también metálica. Esta serie dispone igualmente de un faldón opcional.

The **Carving foot** is equipped with an electrificable and extensible crosspiece. It has a structure of metallic housing and a metallic guide-cables trim. This range has also available an optional modesty panel.

Le pied **Carving** est équipé d'une poutre extensible électrifiable. Il a une structure de carcasse métallique et un enjoliveur guide-câbles également métallique. Cette série dispose également d'un voile de fond optionnel.

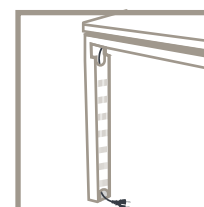
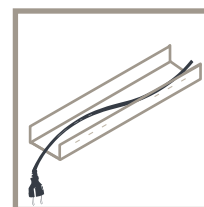
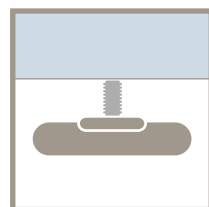

Desarrollado por el equipo de I+D **JGORBE**
Developed by the JGORBE I + D team / Développé par l'équipe I + D de JGORBE

ACABADOS MELAMINA

MELAMINE FINISHES / FINITIONS EN MÉLAMINE



BL



OM

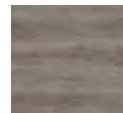
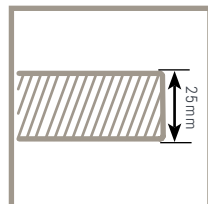

NB



GC



AC

ACABADOS METÁLICOS

METALLIC FINISHES / FINITIONS MÉTALLIQUES



AL



BL



NG

LARGUERO TELESCÓPICO

TELESCOPIC CROSSPIECE / POUTRE TÉLESCOPIQUE



AL



Médidas en cm / Measurements in centimeters / Mesures en centimètres

H: 72cm

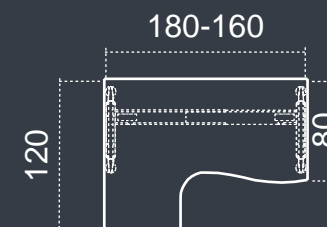
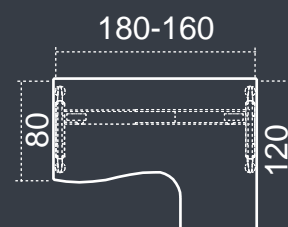
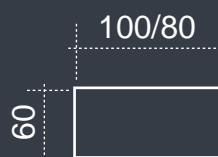
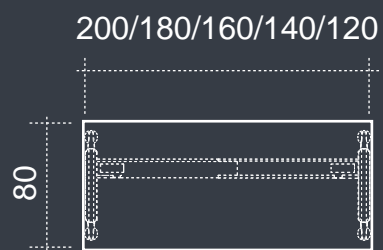



Aneto

La serie **Aneto** se caracteriza por ser un diseño muy ligero al combinar una encimera de 25mm de grosor, un faldón estructural de 19mm de grosor y una estructura metálica que sirve para canalizar el cableado desde el suelo hasta la superficie de trabajo.

The **Aneto** range is characterised by a very light design which matches desktops of 25mm thickness with modesty panels of 19mm thickness and with a metallic struture which acts as guide for the wiring from the floor to the desktop working surface.

La série **Anéto** se caractérise par son design très léger qui combine un plateau de 25mm d'épaisseur avec un voile de fond de 19mm d'épaisseur et une structure métallique qui sert de guide-câbles du sol à la surface de travail

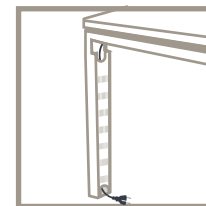
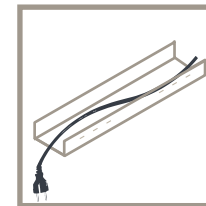
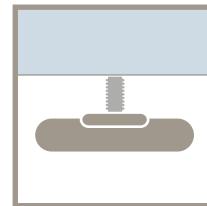

Desarrollado por el equipo de I+D **JGORBE**
Developed by the JGORBE I + D team / Développé par l'équipe I + D de JGORBE

ENCIMERA Y FALDÓN
 DESKTOPS AND MODESTY PANELS
 PLATEAUX ET VOILES DE FOND

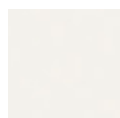

BL



OM

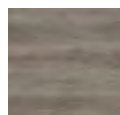
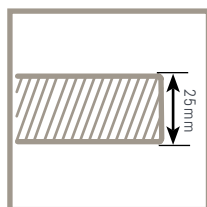

NB



GC



AC

ACABADOS METÁLICOS
 METALLIC FINISHES / FINITIONS MÉTALLIQUES



AL



BL



NG



Méridas en cm / Measurements in centimeters / Mesures en centimètres

H: 72cm

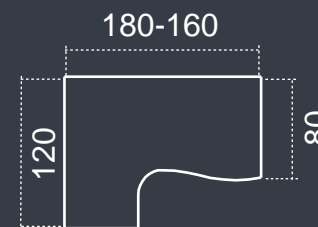
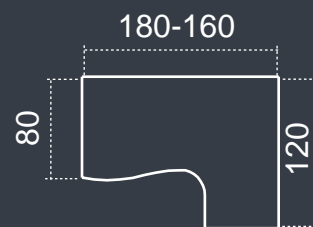
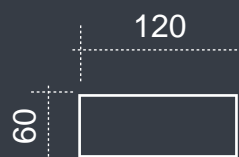



Reunión Aneto-Carving

Aneto-Carving Meeting

Réunion Aneto-Carving

Las mesas de reunión de las series *Carving/Aneto* se caracterizan por ser de diseño ligero al combinar encimeras de 25mm de grosor con estructuras metálicas de tipo península en varios acabados.

The meeting tables of the *Carving-Aneto* ranges are characterised by their light design which mixes desktops of 25mm thickness and metallic structures of peninsula type in different finishes.

Les tables de réunion de las séries *Carving-Aneto* se caractérisent par leur design léger qui combine des plateaux de 25mm d'épaisseur avec des structures métalliques du genre péninsule en différentes finitions.

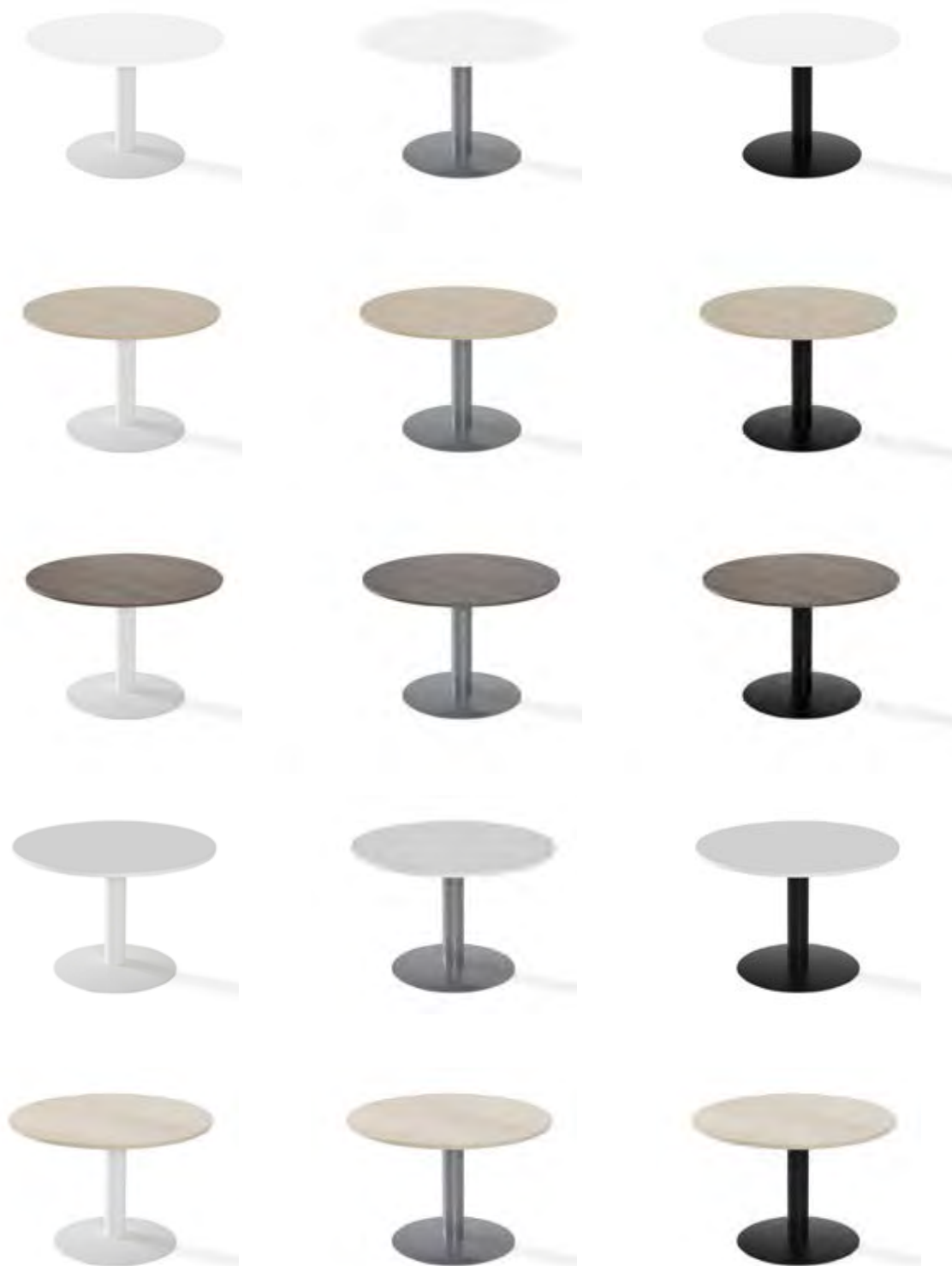
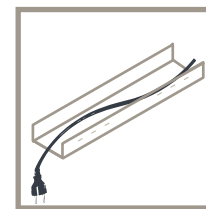
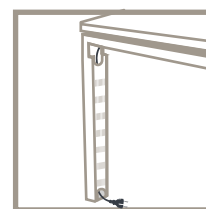
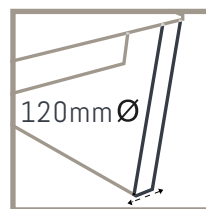

Desarrollado por el equipo de I+D **JGORBE**
 Developed by the JGORBE I + D team / Développé par l'équipe I + D de JGORBE



ACABADOS MELAMINA
MELAMINE FINISHES / FINITIONS EN MÉLAMINE

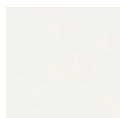

BL



OM

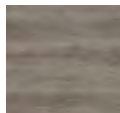
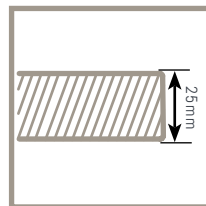

NB



GC



AC

ACABADOS METÁLICOS
METALLIC FINISHES / FINITIONS MÉTALLIQUES



AL



BL



NG

Méridas en cm / Measurements in centimeters / Mesures en centimètres

H: 72cm

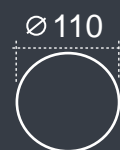



Neko





Neko

Reunión Neko

Neko Meeting / Réunion Neko

Encimera de melamina de 25mm de grosor. Patas tubulares de 60 x 60mm forman la gama **Neko** de la serie Operativas.

En la línea de mesas de reunión Neko conviven 2 modelos: el Neko con pies autoportantes de 60 x 60mm y el **Neko Executive** con pies de 80 x 80mm y largueros perimetrales. Todas las combinaciones de estructura incluyen encimeras de 25mm de grosor.

Melamine desktops of 25mm thickness and tubular legs of 60mm X 60mm form the **Neko** line of the Operativa range.

In the **Neko** Meeting tables range there is two different models: the **Neko** with self-supporting feet of 60mm X 60mm and the **Neko Executive** with feet of 80mm X 80mm and perimeter crosspieces. All structure combinations include desktops of 25mm thickness.

Des plateaux de mélamine de 25mm d'épaisseur et des piètements tubulaires de 60mm X 60mm forment la gamme **Neko** de la serie Opérativas.

Dans la série de tables de réunion Neko nous trouvons deux modèles: la **Neko** avec pieds autoportants de 60mm X 60mm et la **Neko Executive** avec pieds de 80mm X 80mm et poutres périmétrales. Toutes les combinaisons de structure incluent des plateaux de 25mm d'épaisseur.



Desarrollado por el equipo de I+D **JGORBE**
 Developed by the JGORBE I + D team / Développé par l'équipe I + D de JGORBE

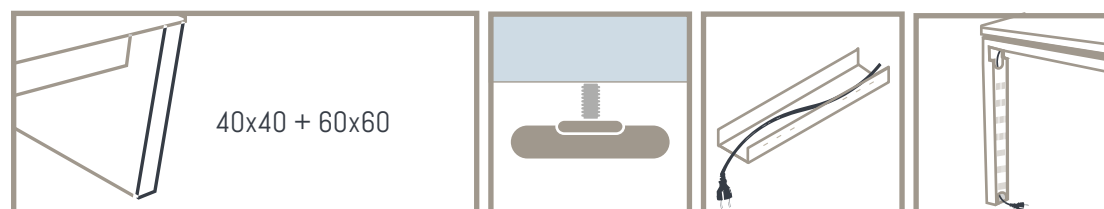
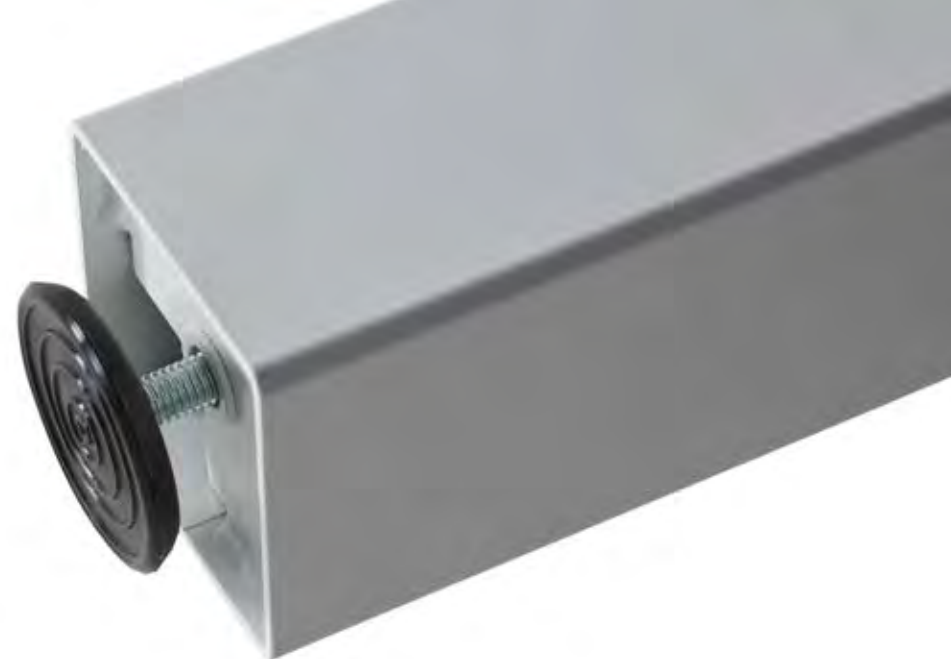

Reunión Neko / Neko Meeting / Réunion Neko

H: 72cm

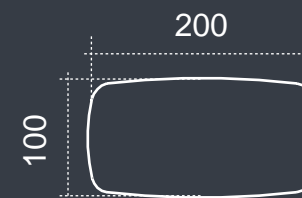

ACABADOS MELAMINA
MELAMINE FINISHES / FINITIONS EN MÉLAMINE

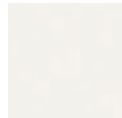

BL



OM

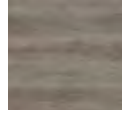
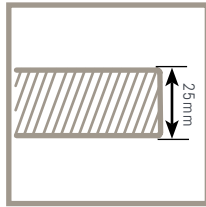

NB

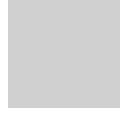

GC



AC

ACABADOS METÁLICOS
METALLIC FINISHES / FINITIONS MÉTALLIQUES



BL-AL



Méridas en cm / Measurements in centimeters / Mesures en centimètres

H: 72cm

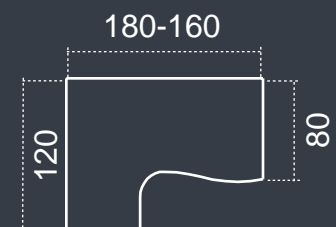
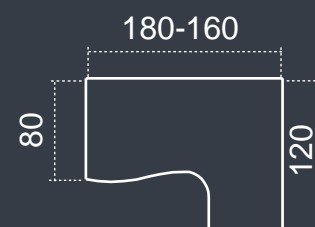
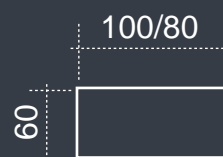



Reunión Neko Executive

Neko Executive Meeting
Réunion Neko Executive

En la línea de mesas de reunión Neko conviven 2 modelos: el Neko con pies autoportantes de 60 x 60mm y el Neko Executive con pies de 80 x 80mm y largueros perimetrales. Todas las combinaciones de estructura incluyen encimeras de 25mm de grosor.

In the Neko Meeting tables range there is two different models: the Neko with self-supporting feet of 60mm X 60mm and the Neko Executive with feet of 80mm X 80mm and perimeter crosspieces. All structure combinations include desktops of 25mm thickness.

Dans la série de tables de réunion Neko nous trouvons deux modèles: la Neko avec pieds autoportants de 60mm X 60mm et la Neko Executive avec pieds de 80mm X 80mm et poutres périmétrales. Toutes les combinaisons de structure incluent des plateaux de 25mm d'épaisseur.

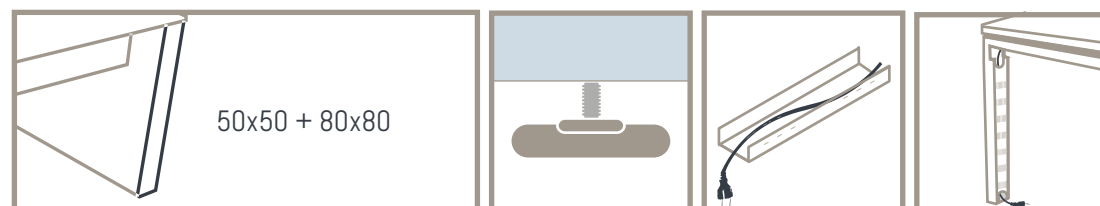

Desarrollado por el equipo de I+D **JGORBE**
Developed by the JGORBE I + D team / Développé par l'équipe I + D de JGORBE

ACABADOS MELAMINA

MELAMINE FINISHES / FINITIONS EN MÉLAMINE

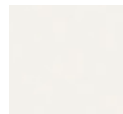

BL



OM

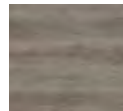
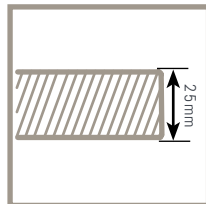

NB

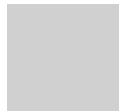

GC



AC

ACABADOS METÁLICOS

METALLIC FINISHES / FINITIONS MÉTALLIQUES



BL-AL



LARGUEROS ESTRUCTURALES

STRUCTURAL CROSSPIECES / POUTRES STRUCTURELLES



AL

Méridas en cm / Measurements in centimeters / Mesures en centimètres

H: 72cm

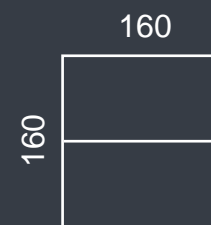
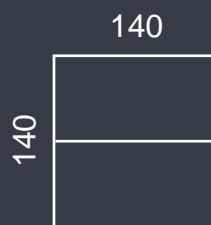
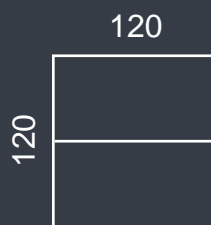



A modern office interior with a dark blue slatted wall. In the foreground, a light-colored desk with a dark base is partially visible, with two dark chairs tucked under it. A tall, thin floor lamp with a white cylindrical shade and a white circular base stands in the center. To the right, a light-colored wooden bookshelf with two shelves of books and two drawers with silver handles is positioned against the wall. Two decorative spherical objects are on top of the bookshelf. The floor is a light, neutral color.

Color



Color

Encimera y laterales de melamina de 25mm de grosor y faldón estructural de 19mm de grosor en numerosas combinaciones forman la gama de **Color** de la serie Operativas.

Melamine desktops and side cheeks of 25mm thickness and modesty panels of 19mm thickness in a lot of combinations form the **Color** line of Operativas range.

Plateaux et piètements de mélamine de 25mm d'épaisseur et voiles de fond de 19mm d'épaisseur en un grand nombre de combinaisons forment la ligne **Color** de la série Opérativas.

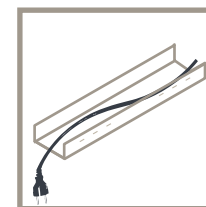
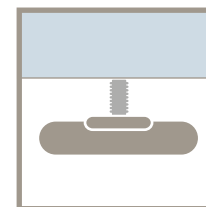
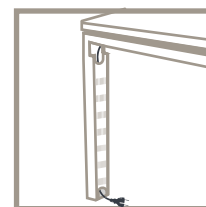
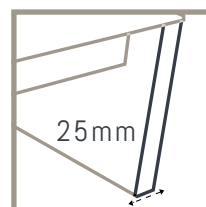

Desarrollado por el equipo de I+D **JGORBE**
Developed by the JGORBE I + D team / Développé par l'équipe I + D de JGORBE

ACABADOS MELAMINA
 MELAMINE FINISHES / FINITIONS EN MÉLAMINE

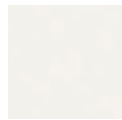

BL



OM

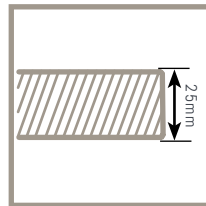

NB



GC



AC



Méridas en cm / Measurements in centimeters / Mesures en centimètres

H: 73cm

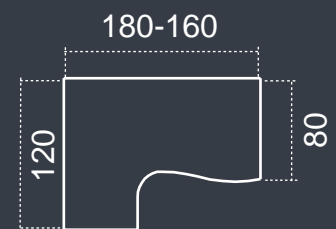
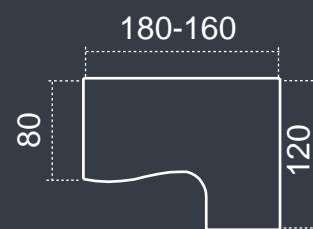
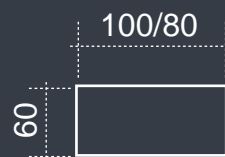



Bench Panel

En la versión de estructura **panel** se combina la sencillez con la eficacia y el diseño con la practicidad; en definitiva es una solución óptima si se busca ahorrar en la implantación de cualquier proyecto.

In the **panel** structure version simplicity mixes with efficacy and plain design with practicality. All gives an optimal solution for the implantation of any project if we look for economy.

Dans la version de structure **panel** se combinent simplicité et efficacité, design simple et sens pratique ce qui en fait une solution optimale si l'on cherche à être économe dans l'implantation de n'importe quel project.

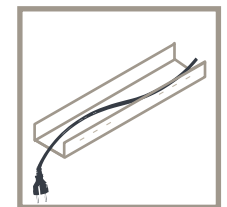
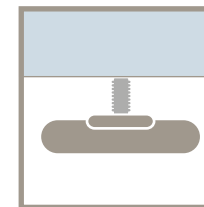
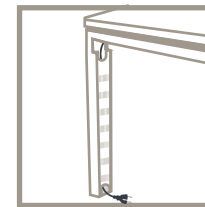
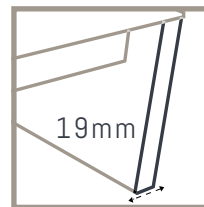

Desarrollado por el equipo de I+D **JGORBE**
 Developed by the JGORBE I + D team / Développé par l'équipe I + D de JGORBE

ACABADOS MELAMINA
MELAMINE FINISHES / FINITIONS EN MÉLAMINE

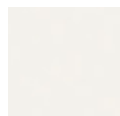

BL



OM

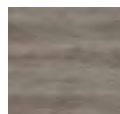
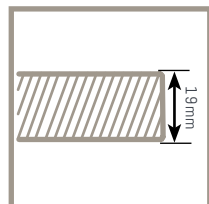

NB



GC



AC

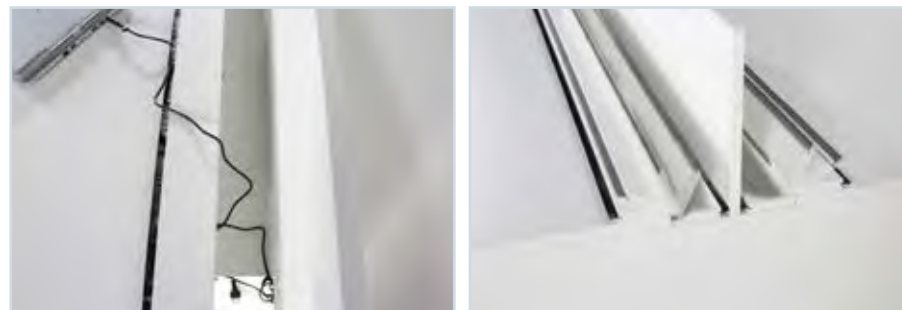

Méidas en cm / Measurements in centimeters / Mesures en centimètres

H: 72cm

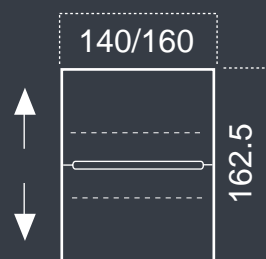



Reunión Color

Color Meeting / Réunion Color

Encimera y laterales de melamina de 25mm de grosor y faldón estructural de 19mm de grosor con numerosas combinaciones forman la gama de **Color** de la serie Operativas

Melamine desktops and side cheeks of 25mm thickness and modesty panels of 19mm thickness in a lot of combinations form the **Color** line of Operativas range.

Plateaux et piètements de mélamine de 25mm d'épaisseur et voiles de fond de 19mm d'épaisseur en un grand nombre de combinaisons forment la ligne **Color** de la série Opérativas.

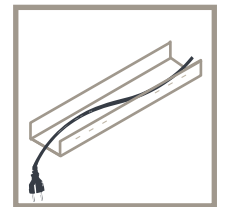
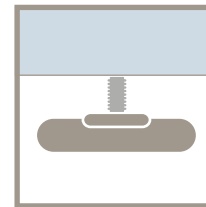
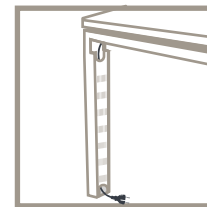
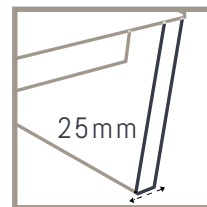

Desarrollado por el equipo de I+D **JGORBE**
Developed by the JGORBE I + D team / Développé par l'équipe I + D de JGORBE

ACABADOS MELAMINA

MELAMINE FINISHES / FINITIONS EN MÉLAMINE

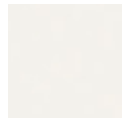

BL

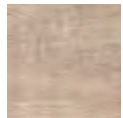

OM

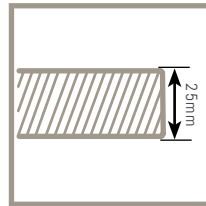

NB



GC



AC



Méidas en cm / Measurements in centimeters / Mesures en centimètres

H: 73cm

Mesa baja para sala de espera

Low table for waiting room

Table basse pour salle d'attente

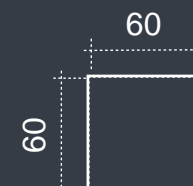
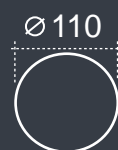

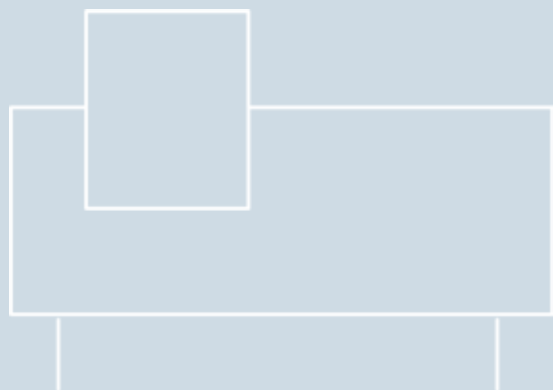

Recepción Basic

Counters Basic / Comptoirs Basic

La recepción es lo primero que ven sus clientes cuando llegan a su empresa por lo que causarles una buena primera impresión es muy importante.

Por eso hemos diseñado una línea de mostradores con aires de modernidad gracias a sus formas limpias y sencillas. Además les hemos dado versatilidad para que pueda combinarlos a su elección. Están fabricados en melamina de 19mm de grosor.

The reception is what your customers see first of your company therefore a good first impression is very important.

We have designed a range of counters with a modern feel thanks to their light and simple forms and we have also given versatility to them allowing any combination of your choice.

The counters are produced in melamine of 19mm thickness.

La réception est ce que vos clients voient en premier de votre entreprise c'est pourquoi une bonne impression est tellement importante.

Nous avons donc donné à nos comptoirs un design avec un air de modernité grâce à ses formes simples et minimalistes en plus d'une versatilité qui vous permet de les combiner à votre convenance.

Les comptoirs sont fabriqués en mélamine de 19mm d'épaisseur.



Desarrollado por el equipo de I+D **JGORBE**
 Developed by the JGORBE I + D team / Développé par l'équipe I + D de JGORBE

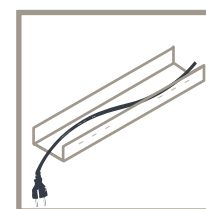
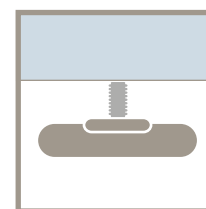
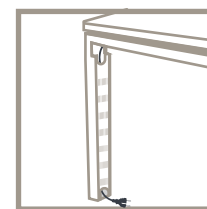
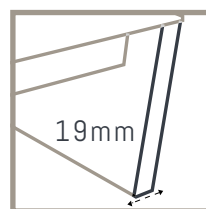

CASCO MOSTRADOR
BODY COUNTER / CORPS DU COMPTOIR



SOBREMOSTRADOR
ABOVE-COUNTERTOPS / SUR-COMPTOIRS



BL OM



NB GC



AC

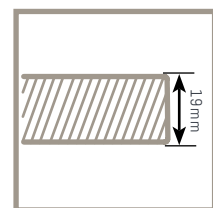

Méridas en cm / Measurements in centimeters / Mesures en centimètres

H: 115cm

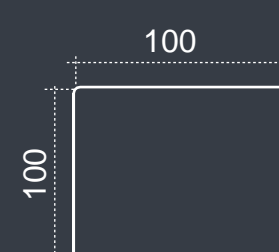
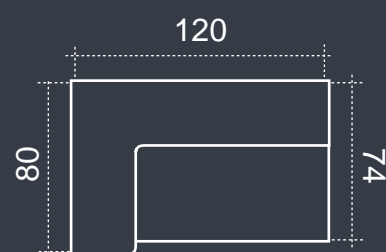
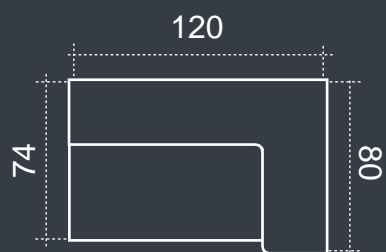
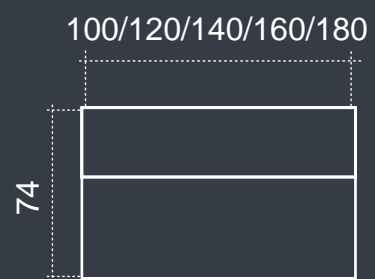

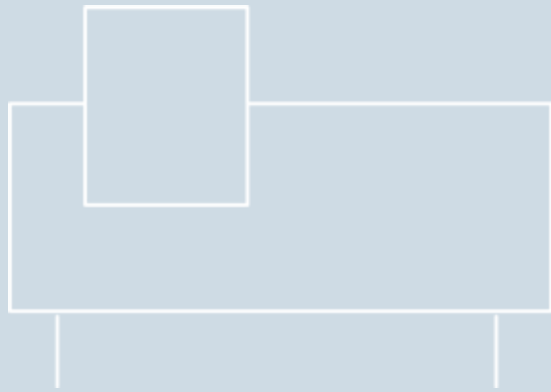

Recepción M3

Counters M3 / Comptoirs M3

En breve dispondrán de una nueva línea de mostradores.

Se trata de una colección diseñada por Maurizio Bernabei, en la que se presentan diferentes módulos de mostradores combinables entre sí.

A new counters range will be soon available. It is a collection designed by Maurizio Bernabei which has different counter modules which can be combined in between.

Une nouvelle ligne de comptoirs sera disponible incessamment.

Il s'agit d'une collection conçue par Maurizio Bernabei qui présente différents modules de comptoirs combinables entre eux.



Desarrollado por **MAURIZIO BERNABEI**
Developed by MAURIZIO BERNABEI / Développé par MAURIZIO BERNABEI

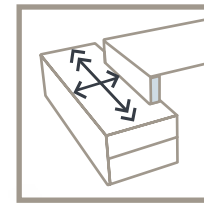
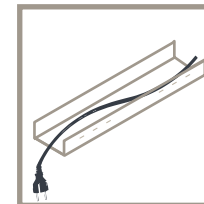
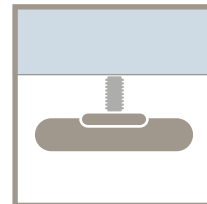
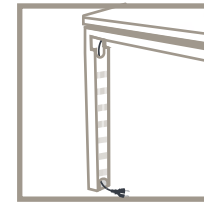
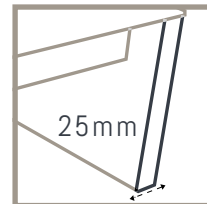

ACABADOS MELAMINA
MELAMINE FINISHES / FINITIONS EN MÉLAMINE



BL



OM

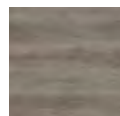
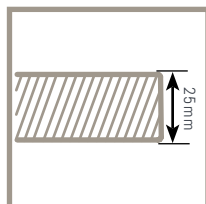

NB



GC

H: 115cm



AC

Próximamente

Prochainement / Next





Call Center

Call Center tiene toda su estructura fabricada en melamina de 19mm de grosor con esquinas redondeadas y costados compartidos. Opcionalmente se le pueden instalar diversos modelos de pasacables sencillos, prácticos y funcionales.

All structure of **Call Center** is produced in melamine of 19mm thickness with rounded corners and shared side cheeks. Optionally different models of simple, practice and fonctionnal guide-cables can be installed.

Call Center a toute sa structure fabriquée en mélamine de 19mm d'épaisseur avec coins arrondis et latéraux communs. Optionnellement on peut lui installer différents modèles de guide-câbles simples, pratiques et fonctionnels.

EXISTE LA POSIBILIDAD DE REALIZAR CADA PROYECTO CON CONFORT ACÚSTICO.
POR FAVOR, PREGUNTE EN FÁBRICA

AVAILABLE THE POSSIBILITY TO REALIZE EACH PROJECT WITH ACOUSTICAL COMFORT.
PLEASE ASK THE FACTORY.

IL EXISTE LA POSSIBILITÉ D'AJOUTER AU PROJET LE CONFORT ACOUSTIQUE.
S'IL VOUS PLAÎT, DEMANDER EN FABRIQUE

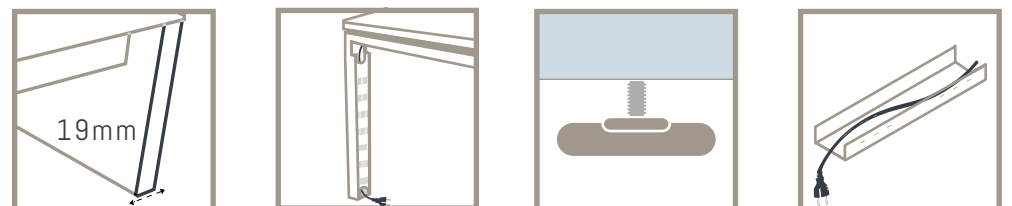
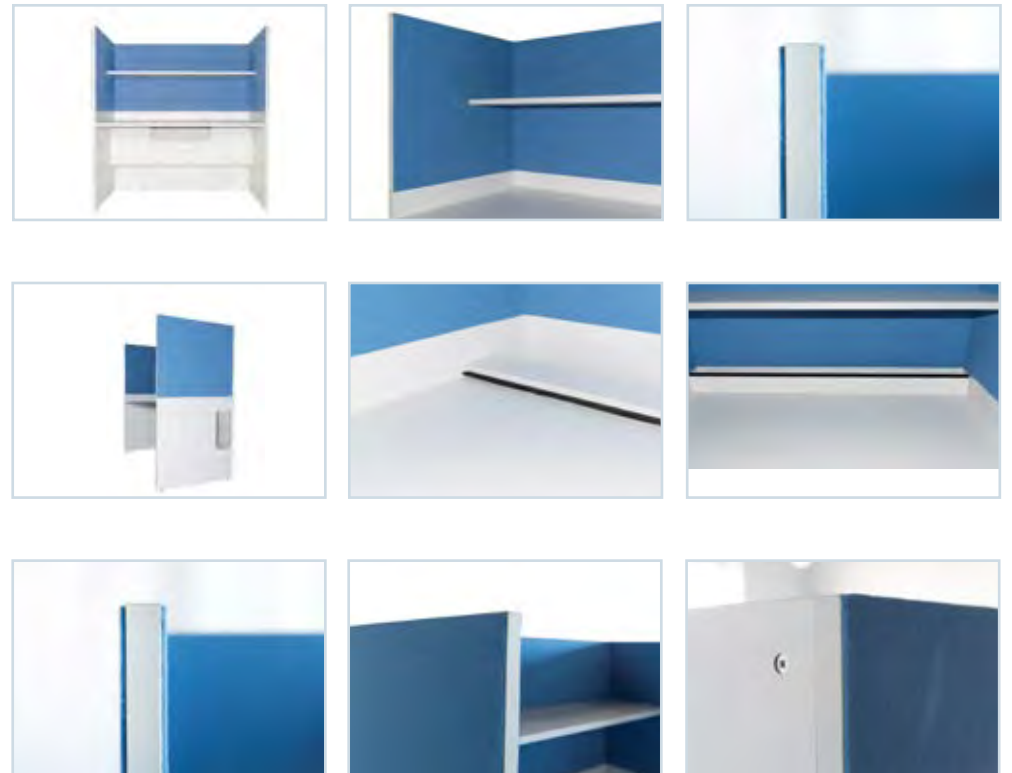

ACABADOS MELAMINA
MELAMINE FINISHES / FINITIONS EN MÉLAMINE



BL



OM

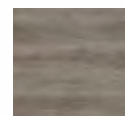
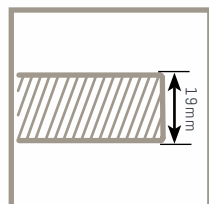

NB



GC



AC



Méidas en cm / Measurements in centimeters / Mesures en centimètres

H: 120cm

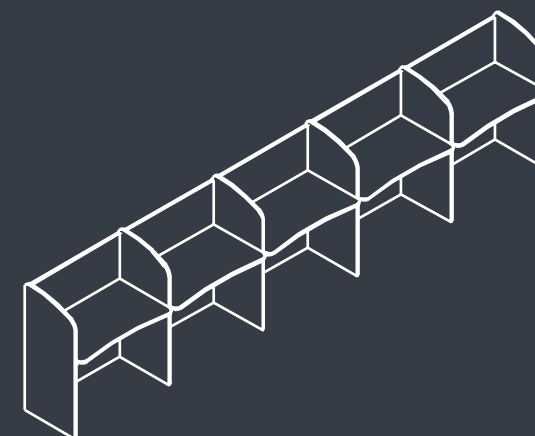
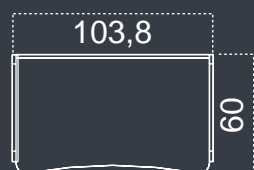

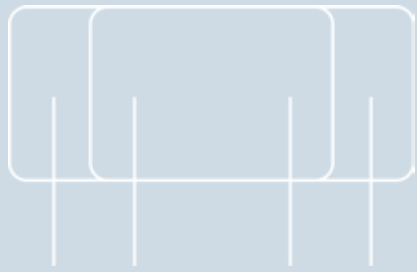

Polivalentes pie fijo

Multipurpose fixed / Polyvalentes fixes

Mesas polivalentes, multifuncionales y fijas.
Ideales para salas de reunión,
de conferencia, multidisciplinarias y aulas.

Multipurpose fixed tables.

Perfect for meeting rooms, conference rooms,
multipurpose rooms and class rooms.

Tables polyvalentes fixes.

Idéales pour les salles de réunion, de conférences,
multidisciplinaires et de classe.



NIVELADORES: Ajustables en altura hasta 13 cm.

ADJUSTABLE SCREWS: Adjustable up to 13cm height.

VÉRINS DE RÉGLAGE: Régulables en hauteur jusqu'à 13cm.

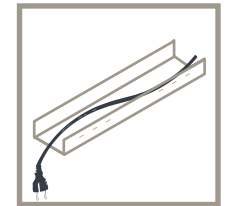
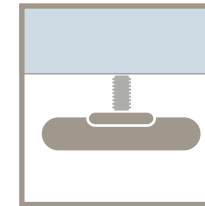
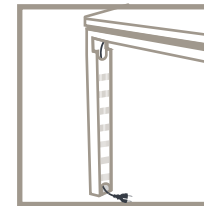
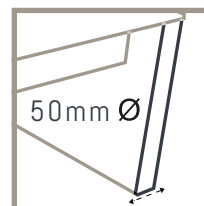

Desarrollado por el equipo de I+D **JGORBE**
Developed by the JGORBE I + D team / Développé par l'équipe I + D de JGORBE

ACABADOS MELAMINA

MELAMINE FINISHES / FINITIONS EN MÉLAMINE

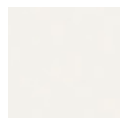

BL



OM

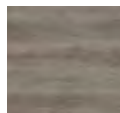
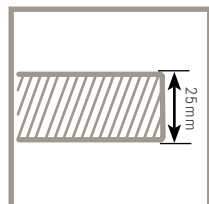

NB



GC



AC

ACABADOS METÁLICOS

METALLIC FINISHES / FINITIONS MÉTALLIQUES



AL



BL



NG



Méridas en cm
Measurements in centimeters
Mesures en centimètres

H: 72cm





Polivalentes pie abatible

Multipurpose hinged
Polyvalentes pliantes

Mesas **polivalentes**, multifuncionales, **abatibles** y de ruedas con freno. Pueden ser transportadas y guardadas con facilidad después de su uso. Ideales para salas de reunión, de conferencia, multidisciplinarias y aulas.

Multipurpose hinged table and castors with brakes. The tables can be transported and stored easily after their use. Perfect for meeting rooms, conference rooms, multipurpose rooms and class rooms.

Tables **polyvalentes** et **pliantes** munies de roues avec freins. Elles peuvent être transportées et se rangent facilement après usage. Idéales pour les salles de réunion, de conférence, multidisciplinaires et de classe.

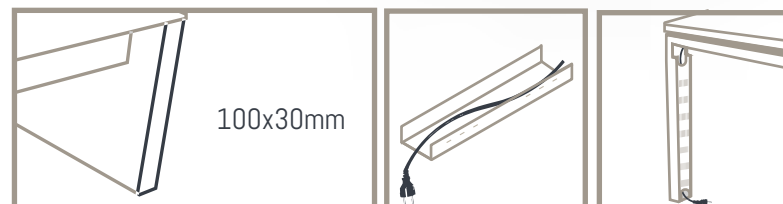

Desarrollado por el equipo de I+D **JGORBE**
Developed by the JGORBE I + D team / Développé par l'équipe I + D de JGORBE

ACABADOS MELAMINA

MELAMINE FINISHES / FINITIONS EN MÉLAMINE

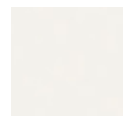

BL



OM

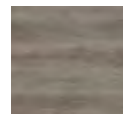
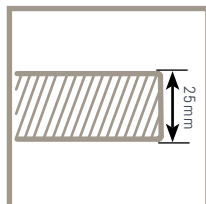

NB



GC



AC

ACABADOS METÁLICOS

METALLIC FINISHES / FINITIONS MÉTALLIQUES



AL



BL



Méidas en cm
Measurements in centimeters
Mesures en centimètres

H: 72cm



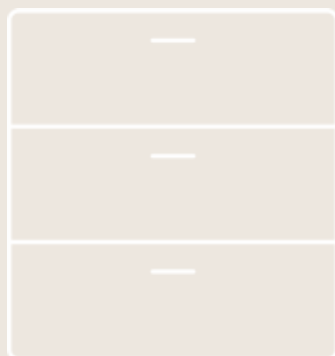

Archivo Bimelamina

Melamine cupboards
Armoires en melamine

Gran combinación de archivadores.
Laterales, techo y trasera exterior de
19mm de grosor.
Estantes de 25mm de grosor.
Todos ellos para la serie de melamina.

Large assortment of cupboards.
Side cheeks, backsides and top pieces of 19mm
thickness.
Shelves in 25mm thickness.
All pieces for the melamine range.

Grand assortiment d'armoires.
Latéraux, arrières extérieurs et pièces supérieures
d'une épaisseur de 19mm.
Étagères d'une épaisseur de 25mm.
Toutes les pièces pour la série en mélamine.

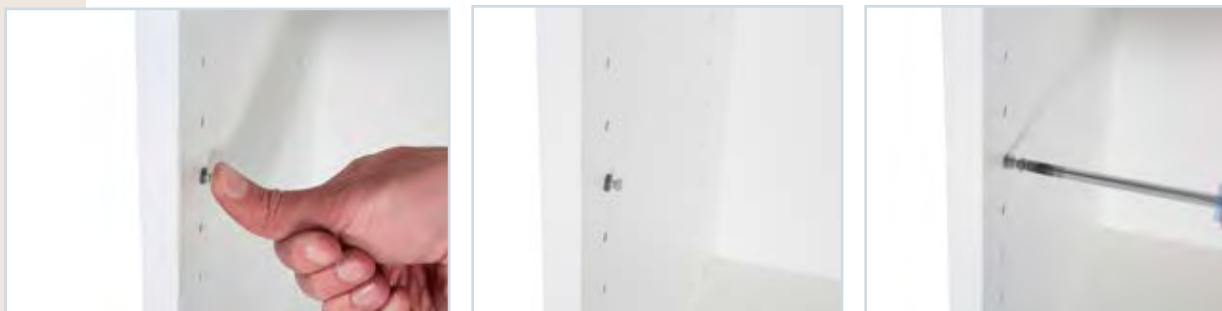
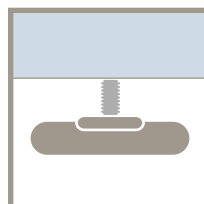
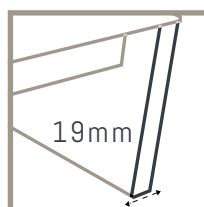

Desarrollado por el equipo de I+D **JGORBE**
Developed by the JGORBE I + D team / Développé par l'équipe I + D de JGORBE

CASCOS MONOCOLOR
CUPBOARD BODY IN SINGLE COLOUR
CORPS DE L'ARMOIRE MONOCHROME

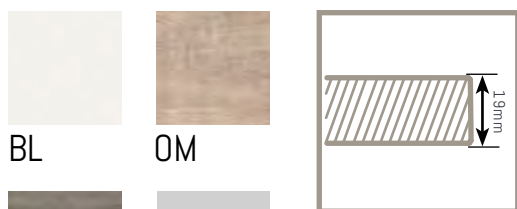

BL

OM

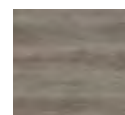

NB

GC



AC

TIRADORES
HANDLES / POIGNÉES



Armarios modulares
Modular cupboards
Armoires modulaires

Vista frontal
Frontal view
Vue frontale

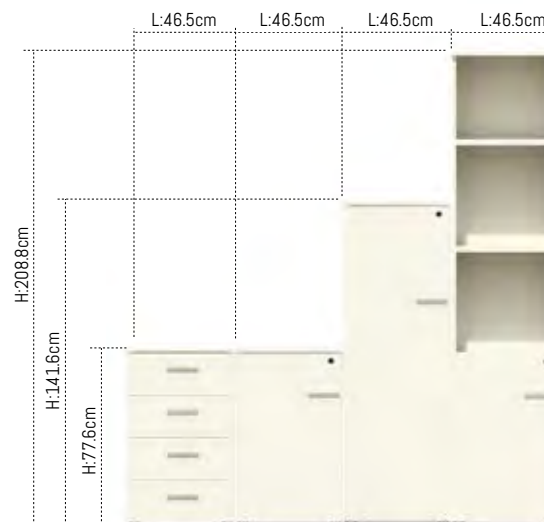

Vista lateral
Side view
Vue latérale

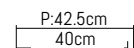

Trasera exterior: 19mm
Backside of 19mm thickness
Partie arrière de 19mm d'épaisseur

Méridas en cm / Measurements in centimeters / Mesures en centimètres

Mueble auxiliar
Side furniture / Meubles auxiliaires



Armarios
Armoires / Cupboards



Armarios estrechos
Narrow cupboards / Armoires étroites

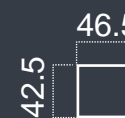

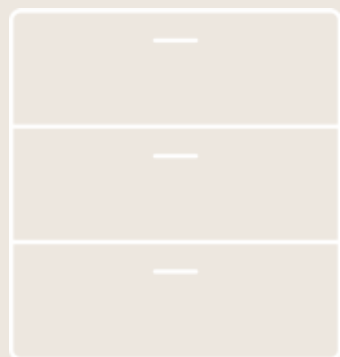

Cajoneras Metálicas

Metallic filing cabinets

Caissons métalliques

Cajoneras rodantes metálicas en combinaciones de 3 cajones o de un cajón y de un archivo.

Rolling filing cabinets in combination of 3 drawers or of one drawer and hanging files.

Caissons métalliques pourvus de roues en combinaisons de 3 tiroirs ou d'un tiroir et d'une archive à dossiers suspendus.



ACABADOS METÁLICOS
METALLIC FINISHES / FINITIONS MÉTALLIQUES



AL



BL

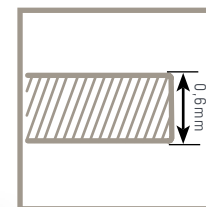

Méridas en cm / Measurements in centimeters / Mesures en centimètres

H: 49,5cm

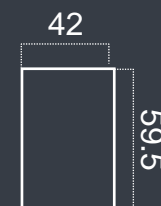

Desarrollado por el equipo de I+D **JGORBE**
Developed by the JGORBE I + D team / Développé par l'équipe I + D de JGORBE

TIRADORES
HANDLES / POIGNÉES

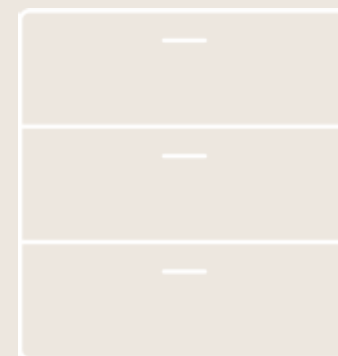
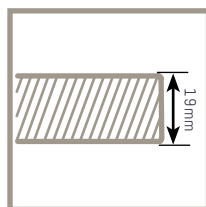

Cajoneras Bimelamina

Melamine filing cabinets

Caissons en mélamine



Cajoneras rodantes con cuerpo de bimelamina y cajones en madera o metal en dos modelos: 3 cajones o 1 cajón y 1 archivo, que pueden ser independientes o acoplarse bajo la mesa. Disponibles en todos los acabados de bimelamina.

Cajoneras fijas con cuerpo de bimelamina y cajones en madera o metal en dos modelos: 4 cajones o 2 cajones y 1 archivo, que pueden ser independientes o acoplarse bajo la mesa. Disponibles en todos los acabados de bimelamina.

Rolling filing cabinets with twomelamine bodies and metal or wood drawers in two models: 3 drawers or one drawer with one hanging files archive which can be independent or coupled under the desktop.

Fixed cabinets with twomelamine bodies and metal or wood drawers in two models: 4 drawers or 2 drawers with one hanging files archive which can be independent or coupled under the desktop.

Available in all twomelamine finishes.

Caissons sur roulettes avec corps de bimélamine et tiroirs en bois ou métal en deux modèles: 3 tiroirs ou un seul avec une archive à dossiers suspendus qui peuvent être indépendants ou s'intégrer sous le plateau.

Caissons fixes avec corps de bimélamine et tiroirs en bois ou métal en deux modèles: 4 tiroirs ou 2 tiroirs et une archive à dossiers suspendus qui peuvent être indépendants ou s'intégrer sous le plateau.

Disponibles dans toutes les finitions de bimélamine.

Méridas en cm / Measurements in centimeters / Mesures en centimètres

H: 58cm

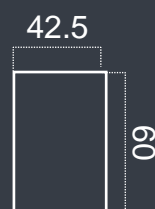

Desarrollado por el equipo de I+D **JGORBE**
Developed by the JGORBE I + D team / Développé par l'équipe I + D de JGORBE

Personalizaciones

Personalization / Personnalisation



Como clientes disponen de un programa especial de fabricación con el que personalizar su despacho eligiendo entre 14 colores de laminado, 6 tipos de madera y 6 tiradores diferentes.
Consúltenos.

As customers you are provided with one special programme of fabrication which allows you to personalise your desks choosing between 14 laminated colours, 6 kinds of wood and 6 different handles.
Please, consult us.

En tant que clients vous disposez d'un programme spécial de fabrication qui vous permet de personnaliser vos bureaux en choisissant entre 14 couleurs de laminé, 6 sortes de bois et 6 différentes poignées
Veuillez nous consulter.

Bench



BL



AL



NG

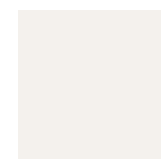

BLANCO-BL
WHITE/BLANC

ACABADOS METÁLICOS
METALLIC FINISHES / FINITIONS MÉTALLIQUES



(BL/BL/BR)



(BL/BL/GA)



(BL/BL/GC)



(BL/BL/GF)



(BL/BL/VO)



(BL/BL/VF)



(BL/BL/AG)



(BL/BL/ZP)



(BL/BL/ZC)



(BL/BL/RS)



(BL/BL/RF)



(BL/BL/CU)



(BL/BL/NA)

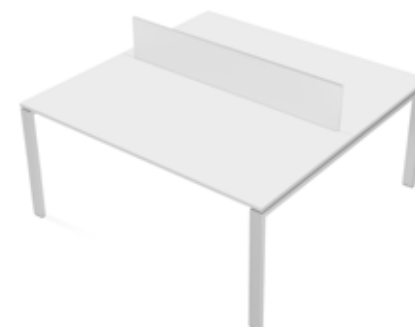

(BL/BL/BL)

Bench



(BR)



(GA)



(GC)



(GF)



(VO)



(VF)



(AG)



(ZP)



(ZC)



(RS)



(RF)



(CU)



(NA)



(BL)

Armario mediano

Medium cupboards / Armoires moyennes



(BL/BR/M4/BR)



(BL/BR/M4/GA)



(BL/BR/M4/GC)



(BL/BR/M4/GF)



(BL/BR/M4/VO)



(BL/BR/M4/VF)



(BL/BR/M4/AG)



(BL/BR/M4/ZP)



(BL/BR/M4/ZC)



(BL/BR/M4/RS)



(BL/BR/M4/RF)



(BL/BR/M4/CU)



(BL/BR/M4/NA)



(BL/BR/M4/BL)

Armario mediano

Medium cupboards / Armoires moyennes



(OM/BR/M4/BR)



(OM/BR/M4/BL)



(OM/BR/M4/GF)



(OM/BR/M4/BL)



(OM/BR/M4/VF)



(OM/BR/M4/VF)



(OM/BR/M4/BL)



(OM/BR/M4/AL)



(OM/BR/M4/BL)



(OM/BR/M4/RF)



(OM/BR/M4/RF)



(OM/BR/M4/CU)



(OM/BR/M4/BL)



(OM/BR/M4/BR)

Armario mediano

Medium cupboards / Armoires moyennes



(BR/M4/ BR)



(GA/M4/ GA)



(GC/M4/ GC)



(GF/M4/ GF)



(VO/M4/ VO)



(VF/M4/ VF)



(AG/M4/ AG)



(ZP/M4/ ZP)



(ZC/M4/ ZC)



(RS/M4/ RS)



(RF/M4/ RF)



(CU/M4/ CU)



(NA/M4/ NA)



(BL/M4/ BL)

Cajoneras

Filing cabinets / Caissons



(BL/BR/M4/GA)



(BL/GA/M4/BL)



(BL/GC/M4/GF)



(BL/GF/M4/BL)



(BL/V0/M4/VF)



(BL/VF/M4/VF)



(BL/AG/M4/BL)



(BL/ZP/M4/AL)



(BL/ZC/M4/BL)



(BL/RS/M4/RF)



(BL/RF/M4/RF)



(BL/CU/M4/CU)



(BL/NA/M4/BL)



(BL/BL/M4/BL)

Cajoneras

Filing cabinets / Caissons



(BR/M4/BR)



(GA/M4/A)



(GC/M4/GC)



(GF/M4/GF)



(VO/M4/VO)



(VF/M4/VF)



(AG/M4/AG)



(ZP/M4/ZP)



(ZC/M4/ZC)



(RS/M4/RS)



(RF/M4/RF)



(CU/M4/CU)



(NA/M4/NA)



(BL/M4/BL)

Call-center



(BL/AG)



(NA/CU)



(ZC)



(ZP/BL)



(GA/BR)



(GF/GC)



(RS/RF)



(VF)



(VO/VF)

Biombos

Screens / Paravents

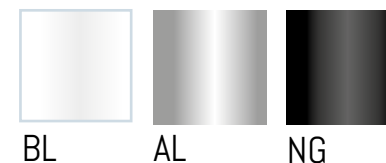

ACABADOS METÁLICOS
METALLIC FINISHES / FINITIONS MÉTALLIQUES



(BR/BL-BR/AL)



(GA/BL-GA/AL)



(GC/BL-GC/AL)



(GF/BL-GF/AL)



(VO/BL-VO/AL)



(VF/BL-VF/AL)



(AG/BL-AG/AL)



(ZP/BL-ZP/AL)



(ZC/BL-ZC/AL)



(RS/BL-RS/AL)



(RF/BL-RF/AL)



(CU/BL-CU/AL)



(NA/BL-NA/AL)

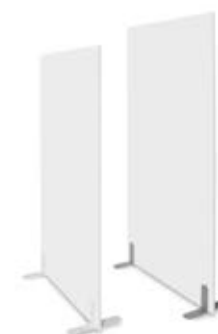

(BL/BL-BL/AL)

Bases



Unicolores

In single colour / Monochrome



Tiradores

Handles / Poignées

M1

210 mm x 40 mm



BEIGE ROSADO (BR) GRIS ARCILLA (GA) GRIS CLARO (GC) GRIS GRAFITO (GF) VERDE ÓPALO (VO) VERDE FUERTE (VF) AGUAMARINA (AG) AZUL POLAR (ZP) AZUL CÓSMICO (ZC) ROSA SEDA (RS) ROSA FLAMINGO (RF) AMARILLO CURRY (CU) NARANJA SIENA (NA) BLANCO (BL)

M2

92 mm Ø



BEIGE ROSADO (BR) GRIS ARCILLA (GA) GRIS CLARO (GC) GRIS GRAFITO (GF) VERDE ÓPALO (VO) VERDE FUERTE (VF) AGUAMARINA (AG) AZUL POLAR (ZP) AZUL CÓSMICO (ZC) ROSA SEDA (RS) ROSA FLAMINGO (RF) AMARILLO CURRY (CU) NARANJA SIENA (NA) BLANCO (BL)

M3

165 mm X 55 mm



BEIGE ROSADO (BR) GRIS ARCILLA (GA) GRIS CLARO (GC) GRIS GRAFITO (GF) VERDE ÓPALO (VO) VERDE FUERTE (VF) AGUAMARINA (AG) AZUL POLAR (ZP) AZUL CÓSMICO (ZC) ROSA SEDA (RS) ROSA FLAMINGO (RF) AMARILLO CURRY (CU) NARANJA SIENA (NA) BLANCO (BL)

M4

210 mm X 40 mm



BEIGE ROSADO (BR) GRIS ARCILLA (GA) GRIS CLARO (GC) GRIS GRAFITO (GF) VERDE ÓPALO (VO) VERDE FUERTE (VF) AGUAMARINA (AG) AZUL POLAR (ZP) AZUL CÓSMICO (ZC) ROSA SEDA (RS) ROSA FLAMINGO (RF) AMARILLO CURRY (CU) NARANJA SIENA (NA) BLANCO (BL)

M5

150 mm X 15 mm



BLANCO (BL) ALUMINIO (AL) NEGRO (NG)

M4



ALUMINIO (AL)
210 mm X 40 mm

M6

500 mm X 15 mm



BLANCO (BL) ALUMINIO (AL) NEGRO (NG)

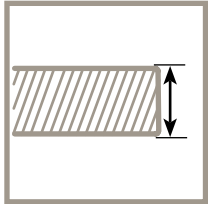

Grosor de la encimera
Desktop thickness / Épaisseur du plateau

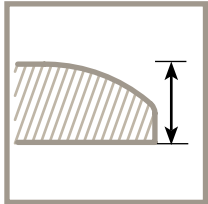

Forma de tapa postformada
Postformed desktop form / Forme de plateau postformé



Grosor del pie-estructura
Foot thickness- Structure / Grosseur du pié - Structure

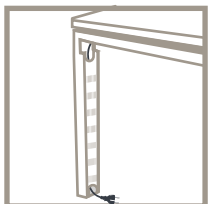

Opción de pie electrificable
Electrifiable foot option available / Option de pié électrifiable disponible

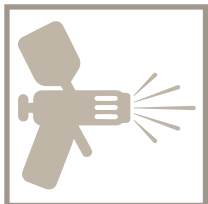

Opción de acabado barnizado
Varnished finish option available / Option de finition vernie disponible

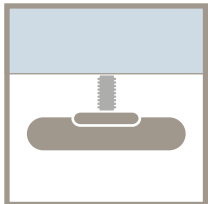

Equipada con niveladores ajustables
Equipped with adjustable height screws / Équipé de vérins de réglage en hauteur

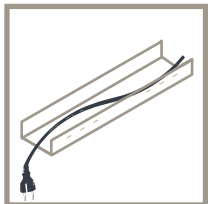

Opción de viga electrificable
Electrifiable crosspiece option available / Option de poutre électrifiable disponible

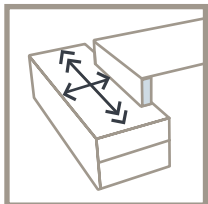

Mesa con apoyo desplazable sobre el mueble auxiliar
Desk with moving support above the side furniture / Bureau avec appui déplaçable sur le meuble auxiliaire

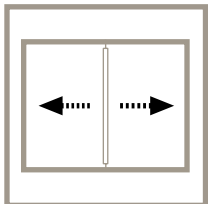

Sistema de tapas deslizantes
Sliding desktop system / Système de plateaux coulissants

JGORBE se reserva el derecho de introducir modificaciones, cambios de detalles, etc... que considere necesarios en beneficio del producto y del cliente.

Debido a los procesos de impresión los colores que aparecen en este catálogo deben considerarse aproximados, no exactos.

Queda prohibido cualquier tipo de reproducción total o parcial de las imágenes, textos, ilustraciones y grafismos del catálogo.

Diseño y desarrollo del catálogo: Mamen Porto

JGORBE reserves the right to technical modifications that consider necessary for this line.

Due to print process the colours showed on this catalogue must be considerer approximate not real.

All kind of total or partial reproduction, copying is prohibited!.

Design and development of the catalogue: Mamen Porto

JGORBE se réserve le droit d'effectuer des modifications techniques, de mesures ou de prix qui lui semble utile pour le bien du produit et du client.

A cause du processus d'imprimerie, les couleurs de ce catalogues doivent être acceptées comme approximatives et non comme exactes.

Le reproduction totale o partielle de ce catalogue est interdite, sauf sous l'autorisation de JGORBE.

Desing et développement du catalogue: Mamen Porto

W o r k p l a c e S o l u t i o n s

J²GORBE[®]

Pol. Ind La Paz C/ Londres

44195 Teruel (Spain)

Tel: +34 978 607 002

info@jgorbe.com

www.jgorbe.com / www.mutesa.com

